

LOW VOLTAGE AC DRIVES

ABB drives for water and wastewater

ACQ580, 0.75 to 500 kW



ACQ580 series

Always flowing. Never still.

Water utilities require reliable solutions securing the flow of water and wastewater.

The ACQ580 drive for water is part of ABB's all-compatible drives portfolio. This robust drive is designed to secure optimal operation of water and wastewater pumps, while ensuring low energy consumption.

Table of contents

04–05	All-compatible solutions for water and wastewater applications
06–07	The energy efficient drive for water and wastewater pumping
08–09	Optimizing the flow of water and wastewater in your pumping solutions
10	Built-in pump application software
11	General software features of the drive
13	EMC – electromagnetic compatibility
14–15	Overcome challenges of harmonics
16	Common features throughout the whole ACQ580 product family
17	Comprehensive connectivity
18	Hand-Off-Auto control panel
19	Control panel options and mounting kits
20	Door mounting and daisy chaining
21	Communication and connectivity
22	Thermistor protection modules for increased safety
22	Extended Warranty for continued piece of mind
23	Tools for configuration, monitoring and process tuning
24	Drivetune mobile application for wireless access
25	ABB SmartGuide – ACQ580
26	Complete offering from wall-mounted drives to cabinet installations
27–28	ACQ580-01, compact and robust drive for wall mounting
29	ACQ580-04, high power and optimized for cabinet builders needs
30–31	ACQ580-07, effortless process automation in a ready-made cabinet
32	ACQ580-31, the benefits of a drive without the inconvenience of harmonics
33	ACQ580-34, exceptionally low harmonics in high power
34	EU Ecodesign Regulation
35	Technical specification
37	How to select a drive?
38–43	Ratings, types and voltages
44	Dimensions
45–48	Cooling and fuses
49–52	du/dt filters
53	Sine filters
54–59	Ordering information
60	Choose the right motor for your application
61	Synchronous reluctance motors
62	Selection guide, IE5 synchronous reluctance motors
63	ABB automation products
64–65	Our service expertise, your advantage
66–67	ABB Ability™ Digital Powertrain
68–69	ABB Drives Life Cycle Management
70	Securing the flow of water and wastewater in the pump system

All-compatible solutions for water and wastewater applications

Environment all-compatible

Achieve your environmental goals with our energy-efficient drive for water and wastewater. The all-compatible drives offer built-in energy efficiency calculators. They help you to analyze and optimize your pump processes to reduce stress on the environment. Other environmentally friendly features include the built-in soft pipe fill function to ensure less water hammering on the water pipes, thus preventing the risk of unwanted leaks, unplanned outage and repair costs.

Process all-compatible

Water and wastewater processes consist of many phases which require optimal performance of your pump solution from start to finish. Our robust drives are available with enclosures up to IP55 (UL Type 12). The drive controls virtually any kind of motors from induction and permanent magnet motors to synchronous reluctance motors up to 500 kW. The drive is compatible with a wide range of fieldbus protocols, ensuring reliable communication between the drive and automation system in use.



Business all-compatible

As a reliable global partner, we provide water process solutions that help to keep the life cycle costs of your pump solution stable. Additionally, we help keep your water process productive and consistent in an energy efficient way. Our wide range of water industry products and solutions offer optimal flow of water all hours of the day. This means lower energy consumption, improved productivity, flexibility and ease of use. With offices in over 90 countries and a global technical partner network, we offer technical advice and local support worldwide.

Human all-compatible

You can feel confident using our all-compatible drives for water and wastewater. The drive speaks the language of your pump application, making it easy to set up, configure and use. The intuitive Hand-Off-Auto control panel ensures that you have access to the essential information quickly. For accessing your drive from a distance and receiving valuable analytics, we offer remote monitoring solutions.

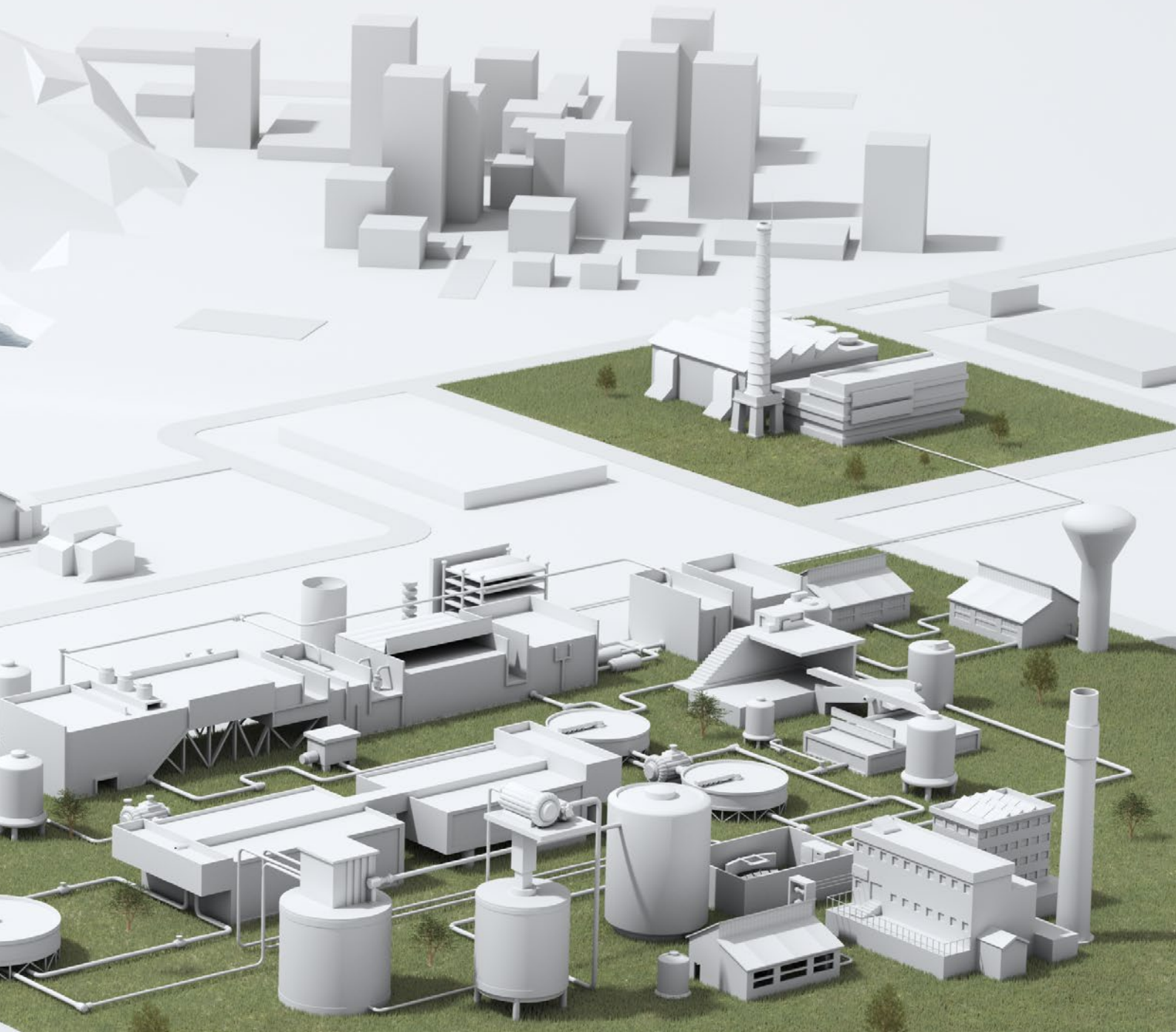

The energy efficient drive for water and wastewater pumping

Whether your pump system requires redundancy in multi-pump applications or built-in pump application functionalities designed for the water and wastewater industry, the ACQ580 is designed to meet your requirements, ensuring your overall water system is more resilient to downtime and malfunction.



Simplicity at your fingertips

The control panel's straightforward primary settings menu with assistants helps you set up the drive quickly and effectively. See more on pages 18-19.

Speaks water-specific terminology

The drive has built-in pump application control programs to secure optimal operation of the water and wastewater pumps. See more on page 10.

Boosting energy efficiency

The energy optimizer helps you to save energy, and the energy efficiency information made available to you helps monitor and save the energy used in your processes. The drive meets IE2 energy efficiency requirements. See more on page 11.



Reliable, integrated safety

Safe torque off (STO) is built-in as standard and the ATEX certified thermistor protection module, EX II (2) GD, CPTC-02 provides enhanced process safety and easy, simplified installation. See more on page 22.



Remote monitoring solutions

Remote monitoring via standard web browsers will help lower costs by reducing the amount of routine site visits. See more on pages 66-67.



The ACQ580 water and wastewater drives are part of ABB's all-compatible drives portfolio. The drives secure the flow of water and wastewater in the pumping system throughout their whole life cycle. The ACQ580 drive is easy to commission and use. With built-in pump functionalities, the drive keeps the pumping system operating optimally, lowering the energy bill. The drive is used in water and wastewater treatment plants, pumping stations, desalination plants, industrial wastewater facilities and irrigation environments. Inflow pumps, transfer pumps, dosing pumps, sludge pumps, booster pumps, submersible pumps as well as compressors, blowers, decanter centrifuges, mixers and fans can be controlled by the drive.



Controls virtually any kind of motor

The drive has the ability to control almost any motors from induction and permanent magnet motors to synchronous reluctance motors. See more on pages 60-61.



Startup and maintenance tool

Drive composer PC tool for startup, configuration, monitoring and process tuning. The PC tool is connected to the drive's control panel with a standard USB cable. See more on page 23.

Robust with built-in features

A robust performer with an enclosure class up to IP55 (UL Type 12), that is simple to select, and easy to install and use. Built-in features such as an EMC filter, choke, a Modbus RTU fieldbus interface and safe torque off (STO) functionality simplify drive selection, installation and use. See more on page 26.



Reliable communication

With its wide range of optional fieldbus adapters and embedded RTU Modbus, the drive enables connectivity with all major automation networks and control systems. See more on page 21.



Input/output extensions

In addition to the standard interfaces, the drive has a built-in slot for additional input/output extension modules. See more on page 21.

Ultra-low harmonic (ULH) solution for a clean network

The ACQ580 ultra-low harmonic drive is designed to minimize the effect of harmonics distortion on your electrical system. The drive keeps the network in the water utility clean and stable. As a result, electrical equipment in the plant wastes less energy as heat and fewer unwelcome disturbances occur. See more on pages 14-15.

Optimizing the flow of water and wastewater in your pumping solutions

The ACQ580 water and wastewater drive is built to help users, designers, OEMs, system integrators and EPC professionals secure pumping of water and wastewater in municipal utilities, pumping stations, industrial wastewater facilities, desalination plants and irrigation environments. It offers long-term, technically-compatible drive solutions supported by full service and support.

Soft pipe filling

Increase the lifetime of the piping and pump system by avoiding pressure peaks.

Quick ramps

Extend the lifecycle of submersible pumps by reducing wear of the mechanical parts using ramp sets to accelerate and decelerate the pumps.

Pump priority

Achieve energy savings with optimal pump alternation by running the higher capacity pumps when the consumption rate is higher.

Anti-cavitation

Extend the pump lifetime and secure the process by detecting cavitation and ensuring optimal pump speed.

Multi-pump control

Ensure stable and uninterrupted production with multi-pump controls by optimizing the speed and number of running pumps.

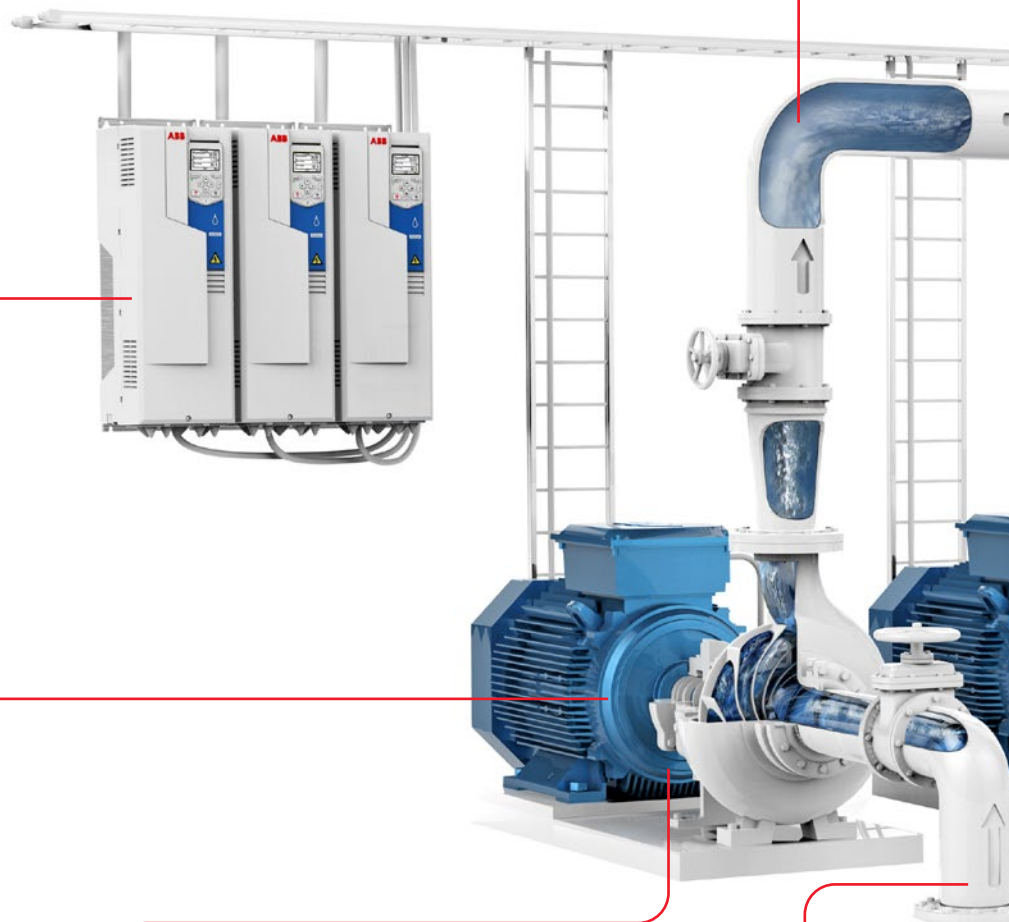

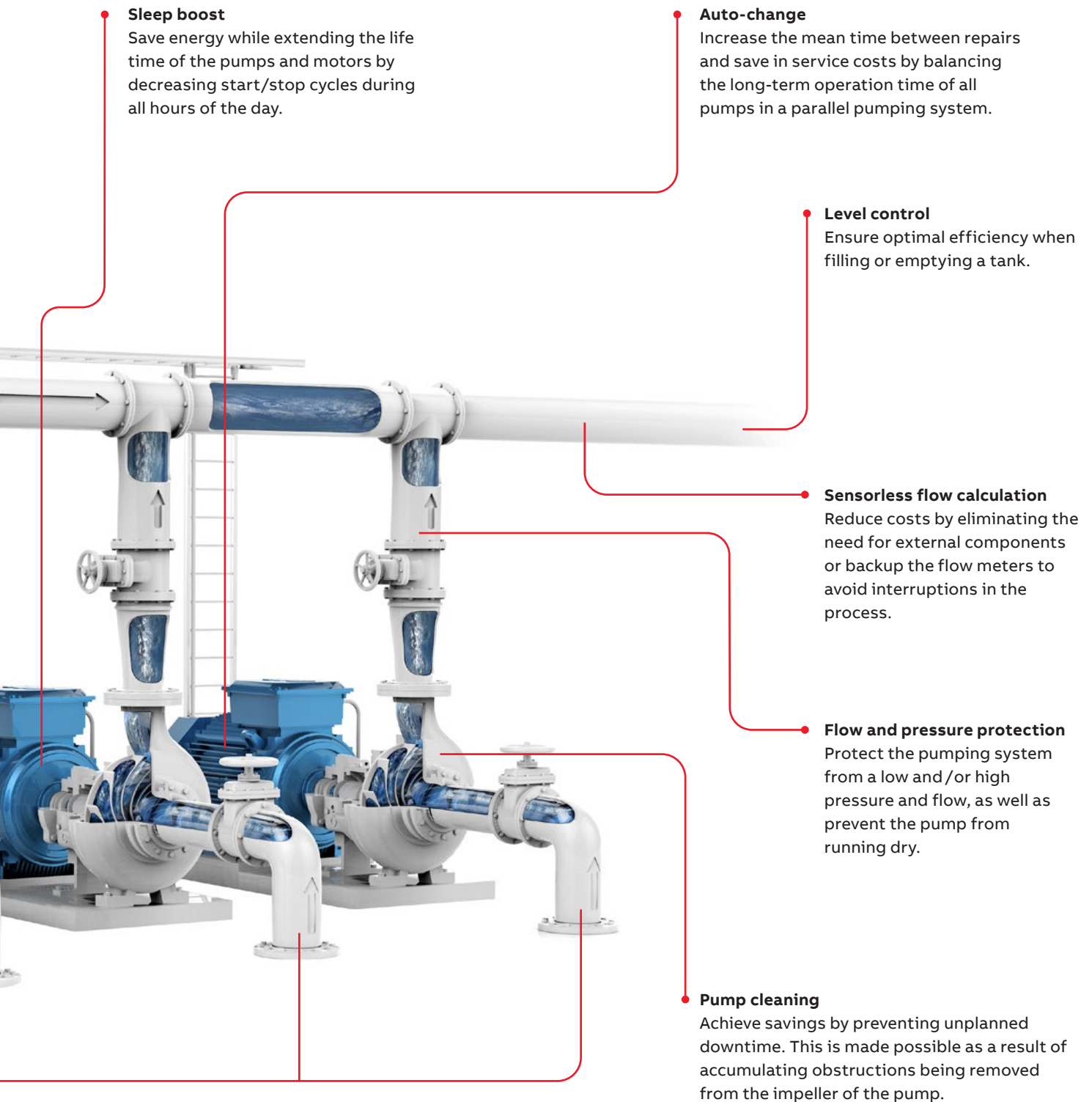

Built-in pump application software

The built-in pump application software in the ACQ580 drives is designed to enhance the reliability and durability of the water and wastewater application in which it is used. The functions protect the pump and secure its optimal functionality, increasing cost efficiency. The built-in functionalities also support the user in securing the flow of the water and wastewater in the pump solution.



Multi-pump functionality Intelligent Pump Control (IPC)

The function maintains stable process conditions for several parallel pumps (up to 8 pumps at the same time) operating together. It is possible to optimize the speed and number of pumps needed when the required flow or pressure rate is variable. This built-in functionality ensures continuous operation for multipump systems even if one or more pumps fail or require maintenance.

Single Pump Control (PFC)

One drive connected to a pump with possibility to connect up to 6 DOL pumps to the system to meet the process requirements.

Soft Pump Control (SPFC)

Same as PFC, but the drive will be connected to a new pump upon startup, enabling smooth acceleration.



Sensorless flow calculation

Measures the amount of water flowing without the need for external sensors. This enables you to reduce costs as there is no need for setting up and using additional sensors or back up the flow meters to avoid interruptions in the process.



Level control

Control the filling or emptying of wastewater storage and water tower tanks. Level control can be used within a station controlling up to eight pumps. The level control function has varying pre-set water levels and the pumps will start and stop based on measured level. This method allows the pumps to run at an efficient speed and ensures the pump sump does not become over contaminated by sediment.



Soft pipe fill

The soft pipe fill function manages the pressure of water by filling the pipeline with a gentle approach. This helps to avoid sudden pressure peaks and reduces the risk of water hammer which can cause damage to the water pipes.



Quick-ramp

Protect bearings when a submersible pump is started without water. Quick ramp allows your pump to reach optimal speed to extend pump life, ensure operation and prevent unplanned outages.



Pump cleaning

Keeps the impeller of the pump clean by running a sequence of aggressive ramps between configurable pump speeds.



Turbidity reduction

When a pump starts as slow as possible, it creates the lowest turbidity values for the water being moved or extracted. When you combine quick ramps and long normal ramps, the drive will protect and run submersible pumps in the most optimal way.



Pump protection

The built-in protection functionalities ensure that pumps can operate at the best possible conditions. The maximum pressure protections help to protect the pump and the system in case of a blockage in the pipeline. In case of a pipe rupture, the minimum pressure protection can generate an alarm or fault and can be programmed to run at certain speed to avoid dirty water entering the pipeline. The inlet pressure protection can help to avoid cavitation.



Dry run protection

This function prevents the pump from running dry. The water pump shaft and impeller are rotating at fast rates. If there is no dry pump protection, the released heat can damage the pump over time, limiting its lifetime.



Anti-cavitation

The cavitation detection function slows down the pump speed or stops the pump when cavitation occurs. Cavitation can happen in flow systems when the pressure in inlet side suddenly drops. It causes vapor bubbles and when the bubbles collapse, they can be destructive to a pump's internal components.

General software features of the drive

Startup assistant allows first-time users to quickly customize the drive, out of the box, according to their needs. This is complemented by a built-in help function to make parameter-by-parameter setting easy.

Motor control in scalar and vector control modes: supporting a wide range of motors including induction, permanent magnet and synchronous reluctance motors.

The energy optimizer feature optimizes the motor flux so that total energy consumption is reduced when the drive operates below the nominal load. The total efficiency can be improved by 1...20% depending on load torque and speed.

Configurable motor features to monitor, protect and early warn against problems in the motor, the pump or the process.

The drive reduces motor noise by spreading the switching frequencies over a user-specified range.

Drive safety and protection features include overcurrent, DC over- and undervoltage, drive overheating and short circuit protection, motor phase loss and supply phase loss detection, external communication loss management and many more.

Diagnostic assistant helps in locating the cause of any disturbance to the drive, and even suggests possible remedies. This reduces process downtime by making repairs or adjustments effortless.

A built-in and stand-alone process PID/loop controller makes the drive a self-governing unit that requires no external logic input from the control room but only an external process measurement.

Load profile feature collects drive values, such as current and stores them in a log. This enables you to analyze and optimize the application with the help of historical data load.

Adaptive programming provides extra flexibility by offering easy alternative for simple programming needs. Download Drive Composer entry for free to start writing your application.

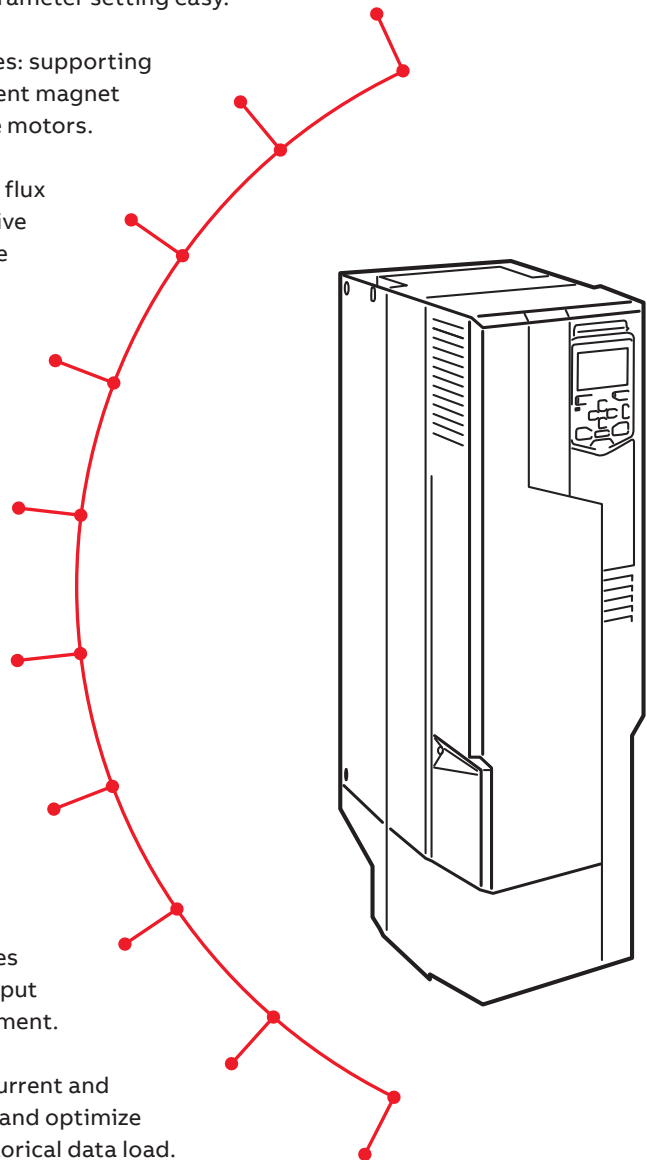



EMC – electromagnetic compatibility

The ACQ580 drive has been designed to meet the EMC requirements set in the product standard IEC/EN61800-3. The wall-mounted ACQ580-01, ACQ580-31 and the small power cabinet-built ACQ580-07 drives meet category C2 high frequency emission limits as standard. The single standing drive module ACQ580-04, ACQ580-34 and high power ACQ580-07 cabinet-built drives meet category C3 limits without options.

EMC standards

The EMC product standard (EN 61800-3) covers the specific EMC requirements stated for drives (tested with motor and motor cable) within the EU. EMC standards such as EN 55011 or EN 61000-6-3/4 are applicable to industrial and domestic equipment and systems including components inside the drive. Drive units complying with the requirements of EN 61800-3 are compliant with comparable categories in EN 55011 and EN 61000-6-3/4, but not necessarily vice versa. EN 55011 and EN 61000-6-3/4 do not specify cable length or require a motor to be connected as a load. The emission limits are comparable to EMC standards according to the table below.

Immunity and emission compatibility

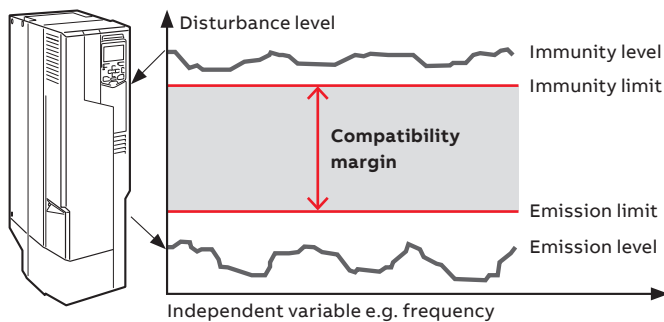

Domestic environments versus public low voltage networks

1st environment includes domestic premises. It also includes establishments directly connected without an intermediate transformer to a low voltage power supply network that supplies buildings used for domestic purposes. 2nd environment includes all establishments directly connected to public low voltage power supply networks.

Built-in chokes to mitigate harmonics

ACQ580 drives are equipped with built-in chokes which provide a sufficient level of harmonic mitigation for most operation environments. The ACQ580-31 ultra-low harmonic drives are available for cases where extremely low harmonic mitigation is required.

Comparison of EMC standards

EMC according to EN 61800-3 product standard before EN 61800-3:2004	EN 61800-3 product standard	EN 55011, product family standard for industrial, scientific and medical (ISM) equipment	EN 61000-6-4, generic emission standard for industrial environments	EN 61000-6-3, generic emission standard for residential, commercial and light-industrial environments
1 st environment. unrestricted distribution	Category C1	Group 1. Class B	Not applicable	Applicable
1 st environment. restricted distribution	Category C2	Group 1. Class A	Applicable	Not applicable
2 nd environment. unrestricted distribution	Category C3	Group 2. Class A	Not applicable	Not applicable
2 nd environment. restricted distribution	Category C4	Not applicable	Not applicable	Not applicable

Overcome challenges of harmonics

ACQ580 ultra-low harmonic drives have excellent harmonics performance and are perfectly suited for places that cannot handle high harmonic content in the network.

The problem with harmonics

Generators in power plants rotate at constant and regulated speed, resulting in a sine-wave shaped current in an AC grid in the ideal case.

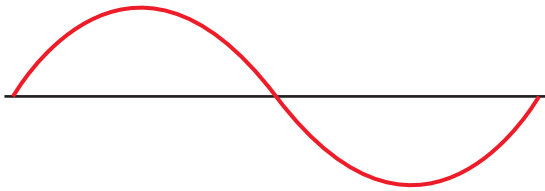

However, in the modern world, the network is not pure sine wave. Electricity networks are affected by harmonics: higher-order oscillations introduced by various types of electrical equipment.

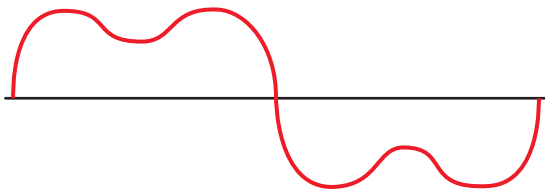

Problems caused by harmonic distortion

High levels of harmonic distortion in an utility can create a wide range of problems. Some of the problems that may be encountered are:

- Premature failure and reduced lifespan of devices often occurs when overheating is present, such as:
 - Overheating of transformers, cables, circuit breakers and fuses
 - Overheating of motors that are powered directly across the line
- Nuisance trips of breakers and fuses due to the added heat and harmonic loading
- Unstable operation of backup generators
- Unstable operation of sensitive electronics that require a pure sinusoidal AC waveform
- Flickering lights

All-in-one concept for a clean network

ABB's ultra-low harmonic (ULH) drives for water are designed with built-in harmonic avoidance systems and complies with IEC61000-3-12. Also extremely low harmonic content helps your system to meet IEEE519 and G5/4

There are many ways to mitigate harmonics and there is no "one size fits all" solution.

The table below compares the THD_i of various harmonic mitigation technologies, along with other comparisons.

	Six-pulse VFD no reactor/ choke	Six-pulse VFD Low DC bus capacitance	Six-pulse VFD + 5% reactor/choke	3-phase VFD Active front end drive *)
Typical THD _i	90-120%	35-40%	35-45 %	3-5 %
VFD system price **)	\$	\$	\$\$	\$\$\$
Footprint	◻	◻	◻◻	◻◻◻
Pros	Simple and low cost solution, not recommended for installations with low quantities of small drives.	Simple and low cost solution that results in some mitigation of current harmonics (THD _i).	Standard solution in water and wastewater applications.	Best harmonic performance of any of the solutions. Easy installation, only 3 wires in and 3 wires out. Ability to boost output voltage during low-line conditions. Unity true power factor.
Cons	High harmonic content, not recommended for installations with higher quantities of drives. Susceptible to poor power quality.	Higher voltage distortion (THD _v), more than the six-pulse VFD with 5% reactor/choke. More susceptible to problems caused by poor power quality. Almost no under voltage ride-through ability.	Systems with a large quantity or large sizes of drives, may require additional harmonic mitigation.	The drive itself generates slightly more heat than a standard six-pulse drive with reactor.

*) Valuations are based on ABB low harmonic drives

**) System price considers VFD & installation costs

harmonic recommendations. Compared to other harmonic mitigation solutions, the problems caused by harmonics are avoided in the first place. ULH drives have excellent harmonic performance technology built-in, including active supply unit and integrated low harmonic line filter. There is no need for external harmonic filters or multi-pulse transformers, leading to significant savings in the footprint.

Reliable operation under special conditions

ULH drives ensure that the motor receives the full voltage, even in low-voltage utility conditions or in a fluctuating network. Thanks to the drives’ capability to provide an output voltage up to 15 percent greater than the supply voltage, applications can overcome voltage drops caused by long supply or motor cables. All this is done without costly additional equipment or over sizing of drive system components.

Savings in total cost of ownership

Electrical utilities may charge additional penalties for consuming reactive power. The ULH drive has unity true power factor as a result of its low harmonics and no

consumption of reactive power. Additionally, the drive is able to compensate the displacement power factor of the network, to which it is connected. This reduces the risk of having additional running costs or buying additional capacitor banks to correct the power factor.

With an integrated design that leverages drive technology as part of the harmonic solution, there is no risk of nuisance trips due to incompatible components, no need for additional hardware and no additional cooling requirements compared to other harmonic mitigation solutions, like passive and active filters. System level efficiency is better when there are less components in the network. Also there is savings in the installation and maintenance costs.

In retrofit projects, the transformer might not be dimensioned to meet the harmonic levels caused by non-linear loads such as standard 6-pulse drives, so there is a risk of overloading the transformer. Thanks to the extremely low harmonic content of ULH drives there is no need to overdimension the transformer, switchgear, or cables.

	Six-pulse VFD + passive filter	Matrix technology drives	Multipulse VFD	Six-pulse VFD + active filter
Typical THD_i	5-10%	5-13 %	12 pulse 10-15% 18 Pulse 5-8% due to actual system dynamics, phase unbalance and background distortion.	4-7%
VFD system price **)	\$\$\$	\$\$\$\$	\$\$\$\$	\$\$\$\$\$
Footprint	□□□□	□□□	□□□□□	□□□□
Pros	Assuming physical space is available, a passive harmonic filter can be added after the drive is installed, if harmonics are determined to be a problem.	Includes regenerative braking.	Traditional harmonic mitigation method.	One active filter can clean up the harmonics from multiple drives/loads.
Cons	Leading power factor at light loads unless the filter's capacitors are switched out of the circuit. Risk of resonances between the filter capacitors and other capacitors in the system. Complex wiring.	Low harmonic mode (5% THD _i) does not allow full speed control throughout the entire frequency range, as it can only modulate up to 93% voltage. No under voltage ride-through of power circuitry due to the lack of DC bus.	Very large footprint. Significant number of points of failure. Optimal harmonic performance requires perfectly balanced AC power feed with little background distortion. Complex wiring and special transformer required. Very difficult to retrofit in the field.	Typically the most expensive solution. The filter becomes a single point of failure for harmonic mitigation. A filter failure could result in significant/immediate harmonic related issues within the system. Complex wiring.

Common features throughout the whole ACQ580 product family

ACQ580 drives have the operation logic, standard features and common options throughout the whole portfolio. Learn it once - use it everywhere.



Standard ACQ580 features

Choke and EMC

- Integrated choke technology mitigates harmonics
- Fulfills standard the EN61000-3-12 standard
- EMC C2 filter for -01 and -31 allows safe installation in first environment
- EMC C3 and common mode filter for -04 and -34 allow safe installation in second environment
- Optional EMC C1 filter ensures the best electro-magnetic performance for first environment. Available for option +E223 and +F316.

Scalar and vector control for process control

- Scalar control for effortless process control
- Vector control for accurate speed and torque control in demanding applications
- Support for induction, permanent magnet and synchronous reluctance motors (SynRM)

Extensive I/O connections

- The ACQ580 features extensive I/O connections for flexible configuration in various applications
- Colored and bigger terminals for easy commissioning and diagnostics

Assistant control panel and primary settings

- The assistant control panel speaks your language
- USB interface for PC and tool connection

Integrated safe torque off (STO)

- Safe torque off for implementing safe machinery
- SIL 3, PL e

Comprehensive connectivity

The ACQ580 drives offer a wide range of standard interfaces. In addition, the drive has two option slots that can be used for extensions including fieldbus adapter modules and input/output extension modules.

All signals and functions for each I/O point can be freely configured via drive settings. AI1, AI2 and AO1 can be set individually for either mA or V signals.

Default control connection diagram below:

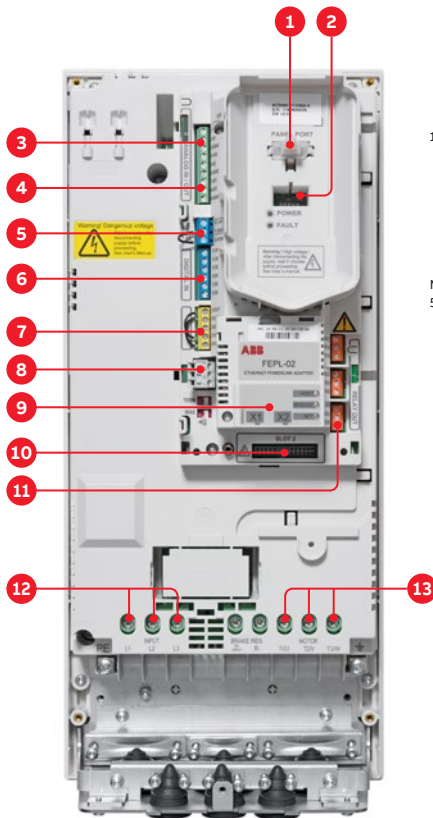

1. Panel port (PC tools, control panel)
2. ABB drive customizer port for programming the drive without mains with CCA-01 tool
3. Analog inputs (2 × AI)
4. Analog outputs (2 × AO)
5. 24 V AC/DC output
6. Digital inputs (6 × DI)
7. Safe torque off (STO)
8. Embedded fieldbus
9. Communication options (fieldbuses)
10. I/O extensions
11. Relay outputs (3 × RO)
12. Mains connection
13. Motor connection

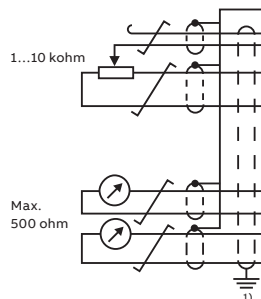

Terminal	Meaning	Default connections
X1 Reference voltage and analog inputs and outputs		
1	SCR	Signal cable shield (screen)
2	AI1	Output frequency/speed reference: 0 to 10 V
3	AGND	Analog input circuit common
4	+10 V	Reference voltage 10 V DC
5	AI2	Actual feedback: 0 to 10 V
6	AGND	Analog input circuit common
7	AO1	Output frequency: 0 to 10 V
8	AO2	Motor current: 0 to 20 mA
9	AGND	Analog output circuit common
X2 & X3 Aux. voltage output and programmable digital inputs		
10	+24 V	Aux. voltage output +24 V DC, max. 250 mA
11	DGND	Aux. voltage output common
12	DCOM	Digital input common for all
13	DI1	Stop (0)/Start (1)
14	DI2	Not configured
15	DI3	Constant frequency/speed selection
16	DI4	Not configured
17	DI5	Not configured
18	DI6	Not configured
X6, X7, X8 Relay outputs		
19	RO1C	Ready run 250 V AC/30 V DC 2 A
20	RO1A	
21	RO1B	
22	RO2C	Running 250 V AC/30 V DC 2 A
23	RO2A	
24	RO2B	Fault (-1) 250 V AC/30 V DC 2 A
25	RO3C	
26	RO3A	
27	RO3B	
X5 Embedded fieldbus		
29	B+	Embedded fieldbus, EFB (EIA-485)
30	A-	
31	DGND	
S4	TERM	Termination switch
S5	BIAS	Bias resistors switch
X4 Safe torque off		
34	OUT1	Safe torque off. Factory connection. Both circuits must be closed for the drive to start. See chapter <i>The Safe torque off function</i> in the <i>hardware manual</i> of the drive.
35	OUT2	
36	SGND	
37	IN1	
38	IN2	
X10 24 V AC/DC		
40	24 V AC/DC+ in	R6 to R11 and all ACQ580-31: Ext. 24 V AC/DC input to power up the control unit when the main supply is disconnected. ³⁾
41	24 V AC/DC- in	

Notes:

- ¹⁾ Ground the outer shield of the cable 360° under the grounding clamp on the grounding shelf for the control cables.
- ²⁾ Connected with jumpers at the factory.
- ³⁾ For frames R1 to R5, an optional I/O module is required to power up with Ext. 24 V AC/DC (see page 21).

Hand-Off-Auto control panel

The control panel features intuitive use and easy navigation. High resolution display enables visual guidance.

Almost anyone can set up and commission the ACQ580 drive using available control panels. You do not need to know any drive parameters, as the control panel helps you to set up the essential settings quickly and get the drive into action.

Control of multiple drives

One control panel can be connected to several drives simultaneously using the panel network feature. The user can also select the drive to operate in the panel network.



1. With the customizable **Home views**, you can monitor the values that matter most, e.g. speed, torque or motor temperature. Select the signals from a ready-made list or choose user-defined parameters.
2. **Options** are used to set a reference, change the motor direction, select the drive, edit Home view pages, and see the fault and warning status.
3. All functions of the control panel are accessed through the **main menu**. It is possible to organize parameters in different ways and store essential parameters for different configurations for any specialized application needed.
4. The help key provides context-sensitive guidance. Faults or warnings can be resolved quickly since the help key provides troubleshooting instructions.
5. The PC tool can be easily connected to the drive through the **USB connector** on the control panel.

Assistant control panel display

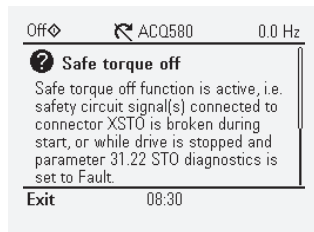

01

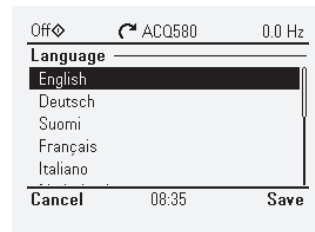

02

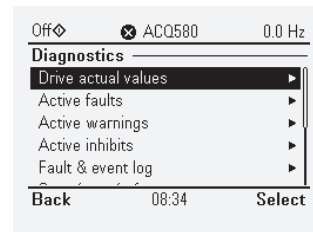

03

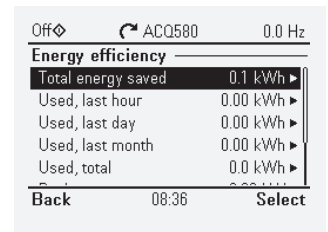

04

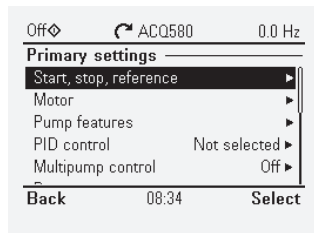

05

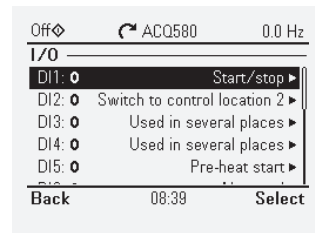

06

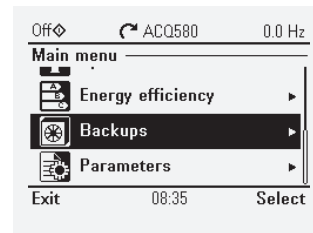

07

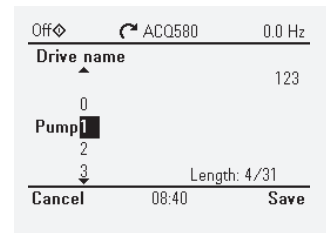

08

01 Help button

- Detailed descriptions related to faults and warnings
- More information about Primary settings options

02 Language options

Access to a selection list that consists of mutually exclusive options such as the language selection list (Access through the main menu).

03 Diagnostics

- Diagnostic information, such as faults and warnings
- Helps to resolve potential problems
- Helps to make sure that the drive setup is functioning correctly

04 Energy efficiency

View and configure parameters related to energy savings, such as kWh counters.

05 Primary settings for ACQ580

With the primary settings you can set motor values, commission multipump, set level control, set soft pipe filling etc. pumping features. When using Primary settings, there is no need to browse the parameters.

06 I/O Menu

- Access to each terminal name, number and electrical status
- Possibility to force inputs and outputs
- Access to sub-menus that provides further information on the menu item and allow to make changes to the I/O connections

07 Backups

Possibility to save parameter settings in the control panel memory and restore parameter settings from a backup to the drive.

08 Text editor

Add information, customize text and label the drive.

Control panel options and mounting kits

The standard delivery of the ACQ580 includes the assistant control panel (requires the +J400 code), but it can be also replaced by other control panels.



Hand-Off-Auto control panel, ACH-AP-H is included in the delivery. USB connection as standard.



Bluetooth control panel, ACH-AP-W
The optional Bluetooth panel enables connection with the Drivetune mobile app. The app is available for free from Google Play and the Apple App store. Together with the Drivetune app and the Bluetooth panel, users can, for example, commission and monitor the drive remotely.



Industrial control panel, ACS-AP-I
The industrial control panel is compatible with all ABB drives, making it simple to use a single panel with different products.



Panel bus adapter, CDPI-01
The panel bus adapter is an ideal choice if there is a need to control multiple drives with a single control panel. The panel bus adapter offers also simplicity for cabinet installations as by using it the control panel can be installed on the cabinet door and the drive can be operated easily and safely.



Blank control panel, CDUM-01
The blank control panel can be used for covering the control panel slot if no control panel or panel bus adapter is needed.



Control panel mounting platform, DPMP-01
This mounting platform is for surface mountings. This also requires CDPI-01 (blank control panel with the RJ-45 connector) and a control panel (assistant, basic, Bluetooth or industrial).



Control panel mounting platform, DPMP-02
This mounting platform is for flush mountings. This also requires RDUM-01 (blank control panel with the RJ-45 connector) and a control panel (assistant, basic, Bluetooth or industrial).



Door mounting kit, DPMP-EXT
The door mounting kit is ideal for cabinet installations. A kit for one drive includes one DPMP-02 and one CDPI-01 (blank control panel cover with RJ-45 connector). If a different control panel than the assistant panel is desired for cabinet door installation, it must be ordered separately.



Control panel mounting kit for outdoor installation DPMP-04/05
Enables control panel outdoor mounting thanks to IP66 protection class, UV resistance and IK07 impact protection rating.

Door mounting and daisy chaining

Improve safety and leverage the full potential of the ACQ580 control panel options with a door mounting kit and panel bus adapter.



Door mounting fosters easy operation and safety. It enables you to operate the drive without opening the cabinet door, saving time and keeping all the electronics behind the closed door. Up to 32 drives can be connected to one

control panel for even easier and quicker operation. When daisy chaining the drives, you need only one assistant control panel. The rest of the drives can be equipped with panel bus adapters.

Cabinet door

Door mounting kit, DPMP-EXT

The kit includes a surface mounting platform for the drive's control panel, panel bus adapter (CDPI-01) and an RJ-45 cable for connecting the control panel and the panel bus adapter.

Assistant control panel

The assistant control panel is delivered as standard with the ACQ580 drives. Also a Bluetooth or industrial control panel can be used.

RJ-45 cable for daisy chaining drives

Panel bus adapter, CDPI-01

The panel bus adapter can be ordered with a plus code +J424 or with an MRP code 3AXD50000009843 as a loose option.



Cabinet, outside

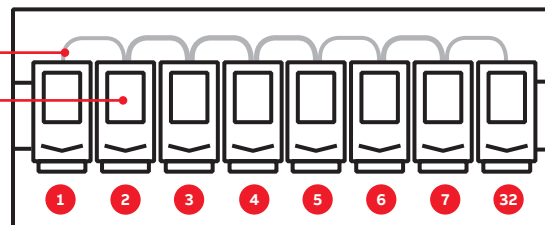

Cabinet, inside

Control panel options

The ACH-AP-H Hand-Off-Auto control panel (plus code +J400) is included as standard in the delivery.

If no code is mentioned in the ACQ580 order, the assistant control panel is automatically added to the delivery. It can be replaced by one of the other +Jxxx options listed below.

Option code	Description	Type designation
+J400	The Hand-Off-Auto control panel as standard in the delivery	ACH-AP-H
+J429	Control panel with Bluetooth interface	ACH-AP-W
+J425	Assistant Control panel with local/remote -logic	ACS-AP-I
+J424	Blank control panel cover (no control panel delivered)	CDUM-01
3AXD50000004419	Panel bus adapter	CDPI-01
3AUA0000108878	Control panel mounting platform (flush mounted, requires also panel bus adapter on the drive)	DPMP-01
3AXD50000009374	Control panel mounting platform (surface mounted, requires also panel bus adapter on the drive)	DPMP-02
3AXD50000016230 *)	Control panel mounting platform (surface mounted, requires also panel bus adapter on the drive, only for ACQ580-04/34)	DPMP-03
3AXD50000217717 *)	Control panel mounting kit for outdoor installation	DPMP-04
3AXD50000240319 *)	Control panel mounting kit for outdoor installation, only for ACQ580-04/34	DPMP-05
3AXD50000010763	Door mounting kit for the panel (for one drive, contains both DPMP-02 and CDPI-01)	DPMP-EXT

*) For availability please contact your local ABB

Communication and connectivity

Options

Fieldbus adapter modules

The ACQ580 comes with Modbus RTU fieldbus interface as standard, and it is also compatible with a wide range of additional fieldbus protocols. Fieldbus communication reduces wiring costs compared to traditional hardwired input/output connections. The fieldbus options can be installed into a slot one (1).

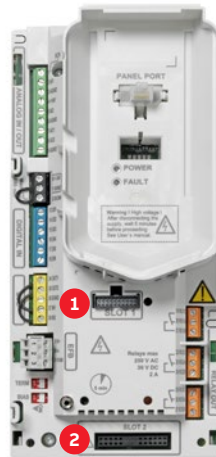

Input/output extension modules

Standard input and output can be extended by using optional analog and digital input/output extension modules. The modules are easily installed in the extension slot two (2) located on the drive.

Fieldbus options



Plus code	MRP code	Fieldbus protocol	Adapter
+K451	68469341	DeviceNet™	FDNA-01
+K454	68469325	PROFIBUS DP, DPV0/DPV1	FPBA-01
+K457	68469376	CANopen®	FCAN-01
+K458	3AUA0000031336	Modbus RTU	FSCA-01
+K490	3AXD50000192786	Two port Ethernet/IP	FEIP-21
+K491	3AXD50000049964	Two port Modbus/TCP	FMBT-21
+K492	3AXD50000192779	Two port PROFINET IO	FPNO-21
+K475	3AUA0000089109	2-port Ethernet	FENA-21



Options

Plus code	MRP code	Description	Type designation
+L501	3AXD5000004420	External 24 V AC and DC 2 x RO and 1 x DO	CMOD-01
+L523	3AXD50000004418	External 24 V and isolated PTC interface	CMOD-02
+L512	3AXD50000004431	115/230 V digital input 6 x DI and 2 x RO	CHDI-01
+L537	3AXD50000033578	ATEX-certified PTC interface, Ex II (2) GD and external 24 V	CPTC-02
+L525	3AXD50000709243	Analogue signal extension 3 x AI and 2 x AO	CAIO-01

Thermistor protection modules for increased safety

ACQ580 supports the ATEX certified thermistor protection module, EX II (2) GD



Thermistor protection module

Option code	Description	Type designation
+L537 +Q971	ATEX certified PTC interface, EX II (2) GD and external 24 V	CPTC-02

Standard input and output can be extended by using optional digital input/output extension modules. The modules are easily installed in the extension slot located on the drive. The CMOD options also enable connection to an external +24 V supply, which allows the control panel, control board, fieldbus and I/O to stay on when main supply is cut off. With the external supply, drive diagnosis and fault tracing can still be carried out.

The ATEX certified thermistor protection module CPTC-02 provides enhanced process safety (SIL2) and easy, simplified installation. It eliminates the requirement for a contactor in the safety circuit saving cost and space.

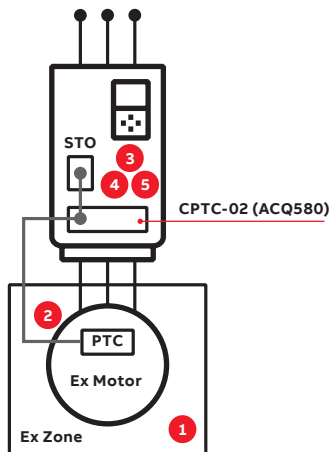

ABB's ATEX thermistor protection module, EX II (2) GD, CPTC-02

With the option +L537 +Q971:

1. Motor temperature rises above the PTC sensor limit temperature
2. The sensor resistance increases very sharply and indicates overheating to the ATEX-certified module
3. The module switches the STO (safe torque off) circuit off, which activates the STO function
4. The STO function disables the control voltage in the power semiconductors of the drive output stage
5. The drive is prevented from generating torque to rotate the motor

► The safe state is guaranteed

Extended warranty for continued piece of mind

Option code	Description
+P932	Extension of warranty, 60 months

Extended warranty offers continued peace of mind after the original factory warranty period. It covers spare parts and repair work in case of a drive failure. Extended warranty is easy to purchase when you feel the time is right. It is available for all ACQ580 drives when a new drive is purchased or at any time during the original warranty period.

Tools for configuration, monitoring and process tuning

ACQ580 has various tools to simplify the commissioning, operation and monitoring of the drive.



Easy configuration for unpowered drives

With the CCA-01 tool, it is possible to configure drive parameters and even download new software from PC to the unpowered ACQ580. The power is supplied by a PC USB port.



Connection with cable

Using the BCBL-01 cable, the PC can be connected directly to the RJ-45 panel port on the ACQ580 drive.



Drive Composer

The Drive Composer PC tool offers fast and harmonized setup, commissioning and monitoring. Drive Composer entry (a free version of the tool) provides startup and maintenance capabilities and gathers all drive information, such as parameter loggers, faults, and backups into a support diagnostics file.

Drive Composer pro provides additional features such as custom parameter windows, graphical control diagrams of the drive's configuration, and improved monitoring and diagnostics.



Connection to assistant panel

When using the Assistant control panel, the Drive composer tool is connected to the drive using the mini USB connection on the panel.

Ordering code	Description	Type designation
3AXD50000032449	PC cable, USB to RJ45	BCBL-01
3AXD50000019865	Cold configurator adapter, packed kit	CCA-01
3AUA0000108087	Drive Composer pro PC tool (single user license)	DCPT-01
3AUA0000145150	Drive Composer pro PC tool (10 users license)	DCPT-01
3AUA0000145151	Drive Composer pro PC tool (20 users license)	DCPT-01

Free Drive Composer entry available at <https://new.abb.com/drives/software-tools/drive-composer>

Drivetune mobile application for wireless access

User-friendly experience with Bluetooth connectivity.

Drivetune mobile app is a powerful tool for performing basic drive startup and troubleshooting tasks. It is possible to connect with drives and access data available in the Internet at the same time. The wireless Bluetooth

connectivity means that users won't need to enter hazardous or difficult-to-reach work areas to access information necessary to help them commission and tune the drive.



• Startup, commission and tune your drive and application with full parameter access

• Optimize performance via drive troubleshooting features

• Create and share backups and support packages

• Keep track of drives installed base

ABB Ability™ Mobile Connect for drives is a module in the Drivetune app. It gives you the access to the technical support for fast problem solving. Mobile Connect makes all the necessary data instantly available to the expert, providing support.

Remote and rapid access to ABB's drive experts can save you and your team considerable time, money and headaches. Check Mobile Connect availability in your country.

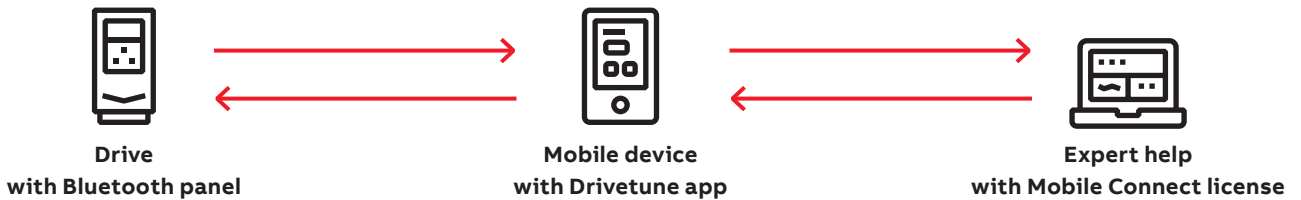

Download Drivetune



Drivetune for commissioning and managing drives

ABB SmartGuide – ACQ580

Being one of the handiest ways to get short and clear visual instructions on drive installation, startup and operation.

Mobile friendly digital user guides provide simple and animated step-by-step instructions to assist with wall mounting of drives, electrical installation and drive programming. The content is frequently updated and further developed, making it your comprehensive source of instructions and help.

Scan the QR code and test it yourself!

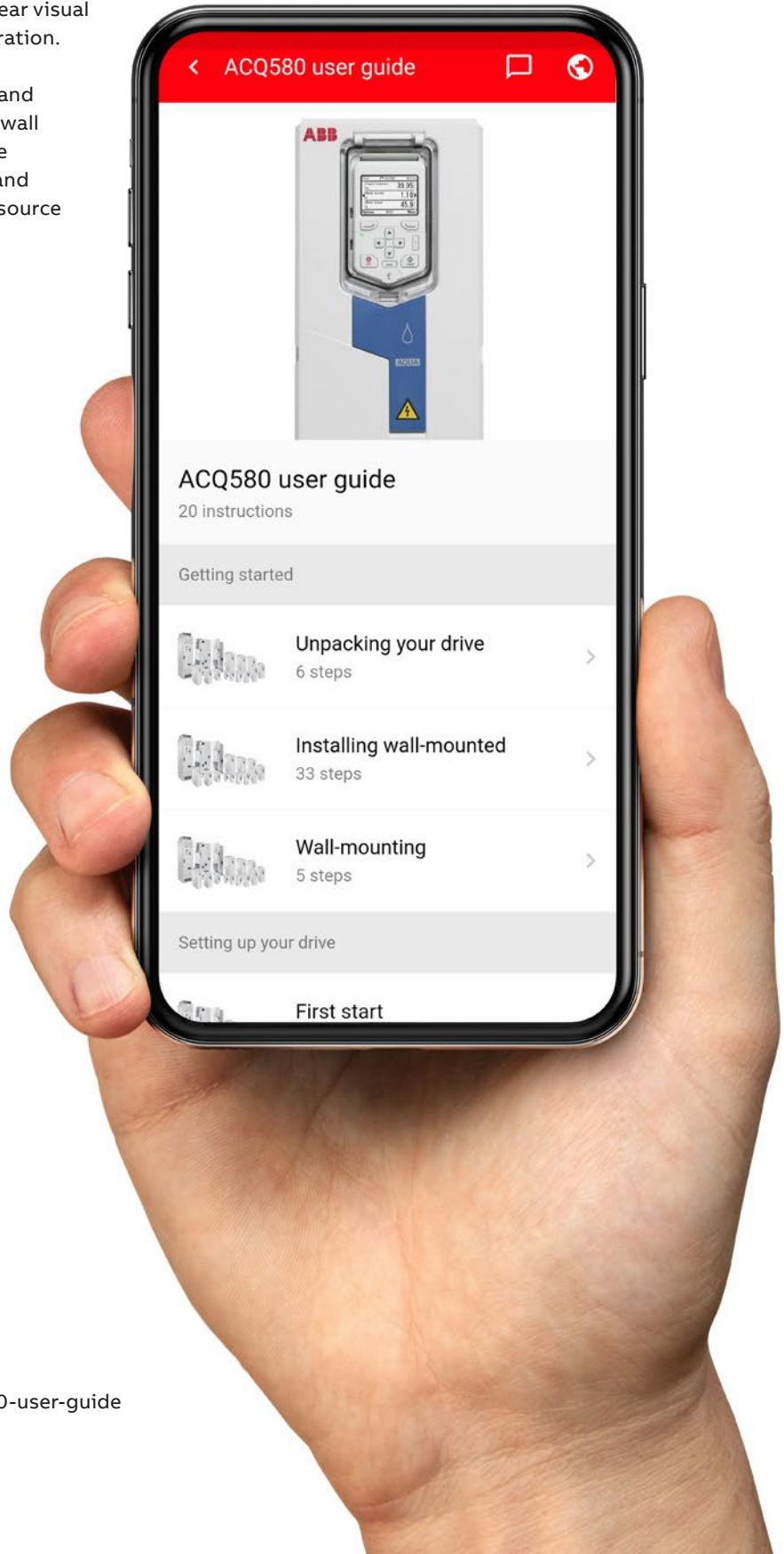

<https://drives-abb.swipeguide.com/guide/acq580-user-guide>
<https://drives-abb.swipeguide.com/>

Complete offering from wall-mounted drives to cabinet installations

No matter the frame size or power range, all ACQ580 drives bring you ease of use, scalability and quality.

- 01 Wall-mounted drives (ACQ580-01 and ACQ580-31)
- 02 Drive modules (ACQ580-04 and ACQ580-34)
- 03 Cabinet-built drive (ACQ580-07)

ACQ580-01 The wall-mounted drive

The wall-mounted drives are available with the power and voltage range from 0.75 to 250 kW (1 to 350 hp), 3-ph 200 to 480 V and 1-ph 200 to 230 V. Drives are available as standard with protection class IP21 (UL Type 1) and IP55 (UL Type 12) with pluscode +B056. Side-by-side mounting, flange mounting and horizontal mounting are all available for the wall-mounted ACQ580 drives.



ACQ580-04 Drive modules for cabinet installations

The ACQ580 drive modules are optimal for system integrators, cabinet builders or OEMs who want to optimize the cabinet design in the 250 to 500 kW (400 to 700 hp) range, but do not want to compromise the easy installation, commissioning and maintenance. Available IP00 (UL Open Type) and IP20.



ACQ580-07 Cabinet-built drives

The cabinet-built drives are type tested ABB solutions offering robust but easy to use cabinets with a new and innovative cooling arrangement. The design is available as standard for all available protection classes IP21/42/54 (UL Type 1/12). The power and voltage range is from 75 kW to 500 kW (100 to 700 hp), 3-ph 380 to 480 V.

ACQ580-31 Ultra-low harmonic drives for wall-mounting

The ULH variant drives produces even below 3% THDi, helping to keep network clean, stable and IEEE519 compliant while eliminating the need for installing external filters or multipulse transformers. The ULH drives for wall-mounting are available from 4 to 110 kW (5 to 150 hp) and protection classes IP21 (UL Type 1) and IP55 (UL Type 12).



ACQ580-34 Ultra-low harmonic drives for cabinet installation

The ULH module is optimal for tailored cabinet design and is available from 132 kW to 355 kW (200 to 400 hp) and protection classes IP00 (UL Open Type) and IP20.

ACQ580-01

Compact and robust drive for wall mounting



- Take advantage of flexible, cabinet-free installation
- Save space and reduce overall costs
- Maintain productivity in harsh conditions
- Minimize downtime and optimize pump operation

The ACQ580 can be installed in normal equipment rooms, or even dusty and wet environments, thanks to the drive's compact wall mountable construction in both IP21 and IP55 configuration that share the same footprint. The robust and protective design ensures that no additional enclosures or

components, such as filters and fans, are needed. The drives provide smaller capital expenses by avoiding or advancing maintenance of external components, which in turn improves the reliability of the drive and the process.

High protection for operation in harsh environments

The wall-mounted IP55 drive is designed for applications exposed to dust, moisture and other harsh environments. It is similar in size to the compact IP21 drives, which provides significant savings in space, maintenance, engineering, material costs, as well as in setup and commissioning time.



Option code	Description
+B056	IP55/UL type 12 Unit

Ready made accessories for simplified cabinet assembly

Installing ACQ580-01 drive modules into Rittal VX25 cabinets is made easier with mechanical and electrical accessory kits. The ready made accessories will save time in design work and reduce the building time to enable faster cabinet delivery. This will enable machine builders,

system integrators and panel builders to built drive packages using their own cabinet design with ABB technology.

For more information and ordering details, please see manual supplement 3AXD50000523191.

Main disconnect switch for increased safety



Main disconnect switch

The main disconnect switch option provides a possibility to disconnect the drive from the main supply when needed. This prewired main disconnect switch option saves time, money and space as it is integrated in the drive. There is no need to install an additional, external isolation devices to the supply side of the drive. The option improves safety as it is always visible, when operating on the drive.

An auxiliary contact allows signaling the switch position to a PLC to avoid unnecessary controller alarms. The switch can be padlocked to the open position to disable drive operation during e.g. maintenance.

The ACQ580 IP55/UL Type 12 units can be ordered with an integrated main switch and/or EMC C1 filter (R1-R5). Having the EMC C1 filter embedded to the drive, there is no need to order, install and test it separately. The integrated filter is already tested with the drive and it is prewired so there is no need for additional cabling.

Option code	Description
+B056	IP55/UL Type 1 2 unit (R1 -R9)
+F278	Integrated main switch (R1 -R5)
+E223	Integrated C1 filter (R1 -R5)
+F316	Integrated main switch and C1 filter (R1 -R5)

Flange mounting

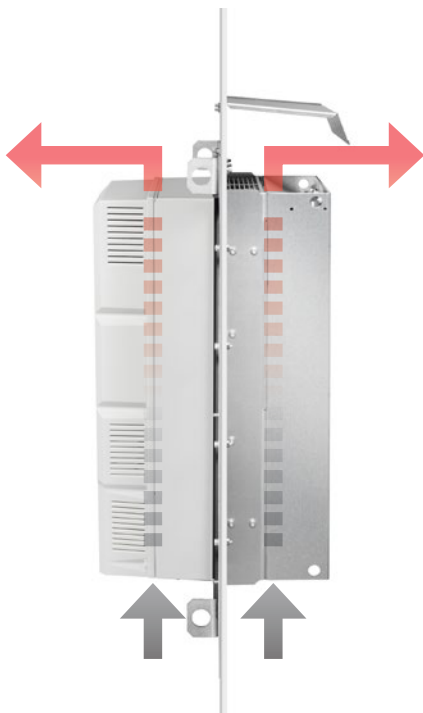

The ACQ580 wall-mounted drive offers flange mounting as an option, separating the control electronics from the main circuit cooling airflow, saving space and ensuring optimal cooling. This results in better thermal management in panel installation. The flange mounting option enables smaller cabinets to be used as the backside of the drive is installed outside of the cabinet. This mounting method minimizes the need for cabinet cooling and decreases the installation cost.

The flange mounting option is compatible only with the standard IP21 units. It maintains the protection class of IP55 on the backside of the drive, while the front side of the drive is IP20. The option is also available as a loose item with an MRP code. If necessary, the conduit box can be removed from the frames R5-R9 with an option code +P944.

Option code	Description
+C135	Flange mounting

ACQ580-04

High power and optimized for cabinet builders needs



- Compact drive module for cabinet mounting
- Save floor space and easy to maintain and service
- High power in compact size
- Easy installation and commissioning with pedestal on wheels and ramp

ACQ580 drive modules have been optimized for assembly into the customer's own cabinets to ensure high quality and compact installation at minimal cost.

Specifically designed for cabinet builders and systems integrators. The module variant is as standard IP00 but available as IP20 with additional finger shrouds. For optimized cabinet usage, features include power input connections on the top of the module and power output on the bottom. The control unit can be either installed inside or outside of the module, enabling free location of input/output terminals. The external control unit can be mounted separately into an SELV enclosure.

Option code	Description
+B051	IP20 Finger shrouds for modules
+H370	Full-size cable connection terminals for input power cables
+0H371	Drive module without full-size output cable connection terminals
+0H354	No pedestal
+OP919	No cabinet installation ramp
+P906	External control unit



ACQ580-07

Cabinets designed with the end user in mind



- Easy to order with ready made standard design and variety of options
- Easy to maintain with easily accessible and smartly positioned components
- EMC and thermal tested cabinet with certified results
- Adaptable to harsh environments with unique cooling system

The ACQ580-07 is a cabinet-built extension to the ACQ580 series. It is easy to use, order and maintain, and quickly available from the factory. An EMC filter, chokes, assistant control panel, Modbus RTU, STO and installation tools are included as standard, and in addition there are several options available to further fulfill your needs. Smartly positioned fans and filters ensure the longevity of the drive and its components. When it is time to do maintenance,

the necessary components are in easily accessible locations. The simple and robust design ensures reliable operation even in harsh environments.

Option code	Description
+B054	IP42 for cabinet built drives
+B055	IP54 for cabinet built drives

Empty cabinet options are available to the customers who need additional space for installation of auxiliary devices such as PLCs, relays, filters, brake resistors or by-pass systems. For more information, please contact your local ABB representative.

Factory acceptance test (FAT)

To ensure that the drive solutions meet the specifications and the customer expectations, ABB offers to have a factory acceptance test (FAT) in drives factory. Remote FAT or visual inspection is possible via online services.

Frame sizes R6-R9

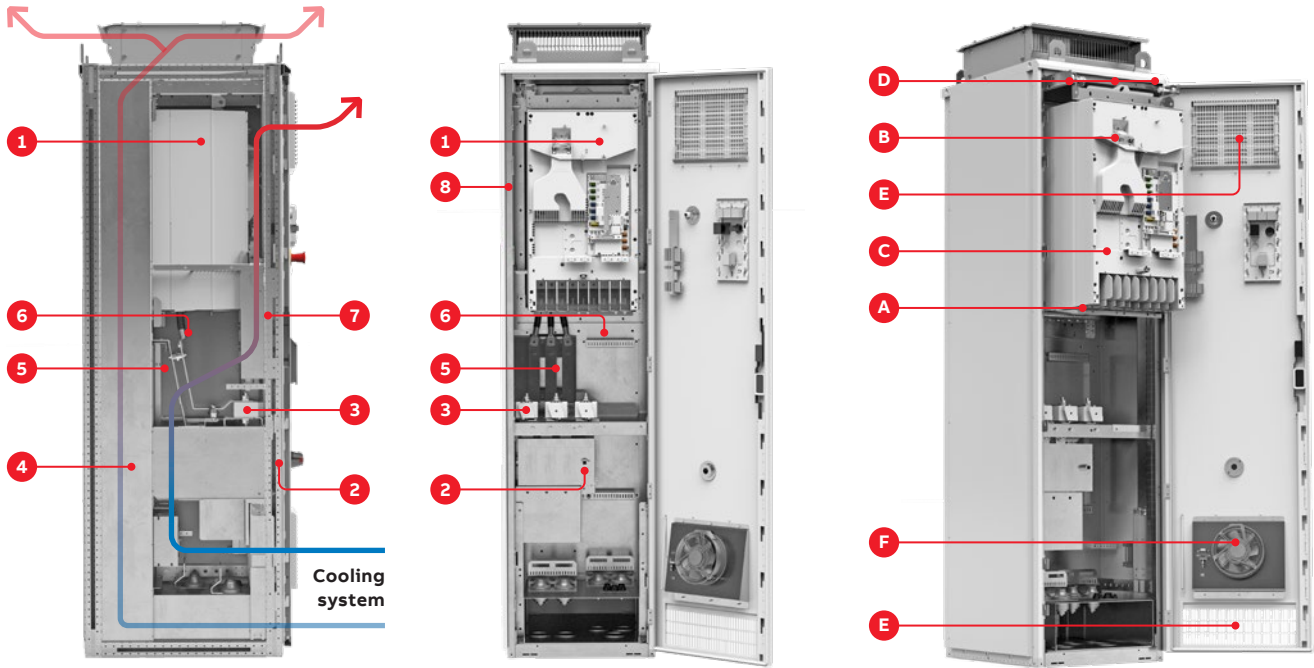

Frame sizes R10-R11

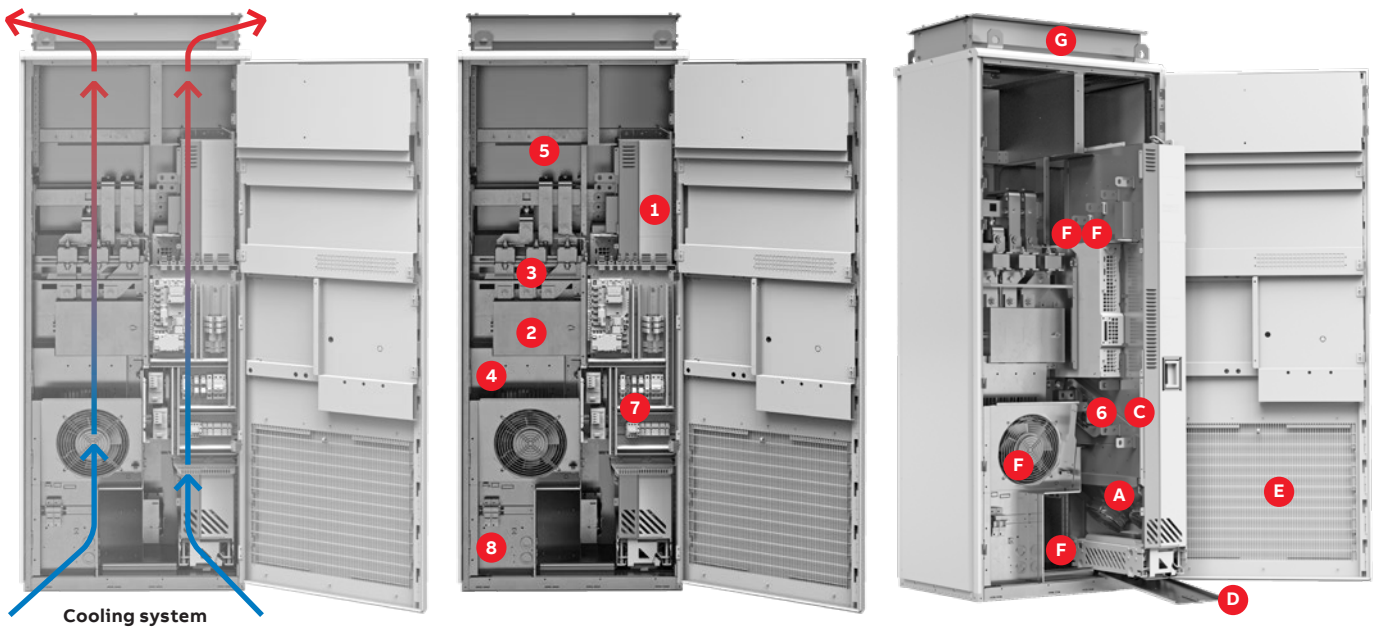

Cabinet components

- 1. Module
- 2. Main switch or MCC8, option +F289
- 3. Fuses
- 4. Space for optional du/dt filter or cabinet heaters
- 5. Space for a line contactor option +F250
- 6. Common mode filter allocation
- 7. Space for safety, ATEX or external power supply options
- 8. Space for options +M600...+M605

Maintenance operation components

- A Main fans
- B Auxiliary fans
- C Capacitors (inside the module)
- D Rails and ramp supporting maintenance operation
- E Filters for dust and external components
- F Other supporting fans for R10 and R11
- G Roof top for R10 and R11 (only IP54)

ACQ580-31

The benefits of a drive without the inconvenience of harmonics



- Full water functionality and clean supply (THDi less than 3%)
- Effortlessly meets harmonic standards and specifications
- No need to overdimension transformers, switchgear or cables
- Simple to install – three wires in, three wires out. No external hardware required

The wall-mountable Ultra-low harmonic drives are available in three compact frame sizes, power range 4 to 110 kW. The drive has full water specific functionality and harmonic content even less than 3%. It helps to keep the supply clean and meets the standards and requirements effortlessly. Everything comes as one package – the drive is easy to install and requires no external hardware.

ACQ580 Ultra-low harmonic drive can be installed in wet and dusty environments, with robust IP55 enclosure. Flange mounting option allows optimal cooling or space saving in compact cabinets.



Option code	Description
+B056	IP55 for wall-mounted drive
+C135	Flange mounting

ACQ580-34

Exceptionally low harmonics in high power



- Optimized for cabinet builder needs
- High power in compact size and clean supply (THDi less than 3%)
- Easy installation and commissioning, no external filters needed
- Easy to maintain and service with pedestal on wheels and ramp

ACQ580 Ultra-low harmonic drive modules have been optimized for assembly into the customer's own cabinets to ensure high quality and compact installation at minimal cost. The drive module is available from 132 kW to 355 kW. Installation and maintenance is made easy with wheeled pedestal and ramp that allows moving the module in and outside of the cabinet.

The module variant is as standard IP00 but available as IP20 with additional finger shrouds. The control unit can be either installed inside or outside of the module, enabling free location of input/output terminals. The external control unit can be mounted separately into an SELV enclosure.

Ready made accessories for simplified cabinet assembly

Installing ACQ580-34 drive modules into Rittal VX25 cabinets is made easier with mechanical and electrical accessory kits.

Option code	Description
+B051	IP20 Finger shrouds for modules
+H370	Full-size cable connection terminals for input power cables
+0H371	Drive module without full-size output cable connection terminals
+OP919	No cabinet installation ramp
+P906	External control unit

The ready made accessories will save time in design work and reduce the building time to ensure faster cabinet delivery. This will enable machine builders, system integrators and panel builders to built drive packages using their own cabinet design with ABB technology.

For more information and ordering details, please see manual supplement 3AXD50000815838.

EU Ecodesign Regulation

The EU has agreed upon new, more demanding regulation (EU) 2019/1781, replacing regulation 640/2009 and setting the minimum efficiency levels not only for direct-on-line rated low voltage induction motors but now also for variable speed drives with a voltage up to 1000 V. The regulation is implemented in two steps July 1, 2021 and July 1, 2023.



Variable speed drives

Step 1: July 1, 2021

IE2 efficiency level mandatory for AC drives

- Power range from 0.12 to 1000 kW.
- 3-phase drives with diode rectifier including ABB's micro, machinery, general purpose, industrial and industry-specific drives.
- Drive manufacturers must declare power losses in percentage of the rated apparent output power at 8 different operating points as well as standby losses. The international IE level is given at the nominal point. Drives fulfilling the requirements will be CE marked.
- All the covered ABB products fulfill the requirements.

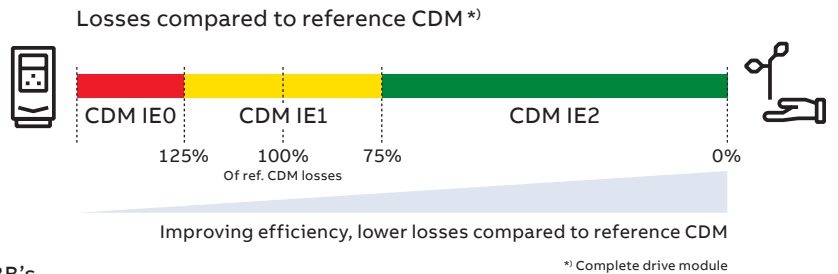

Excluded from the regulation:

- All drives without CE marking
- Following low voltage AC drives: regenerative drives, low-harmonic drives (THD < 10%), multiple AC-output drives and single-phase drives.
- Drive cabinets with already conformity assessed modules
- Medium voltage drives, DC drives and traction drives

Markings on the ABB AC drives

Unique identifier QR code to Ecodesign information



IE class and % loss of rated apparent power 50 Hz, 400 V

IE2 (90;100) 2,3 %

Unique QR codes are located on the rating plate and/or the front side of the drive.

Step 2: July 1, 2023

No changes for drives from July 1, 2021.

For more information, see Ecodesign tool: <https://ecodesign.drivesmotors.abb.com/>



Technical specification

Mains connection											
Voltage range	3-phase, 200-240 V 3-phase, 380-480 V 1-phase, 200-230 V										
Power range	<table border="1"> <tr> <td>ACQ580-01 wall-mounted</td> <td>0.75 to 75 kW, 3-phase, 230 V 0.75 to 250 kW, 3-phase, 400 V 0.37 to 37 kW, 1-phase, 230 V</td> </tr> <tr> <td>ACQ580-04 module</td> <td>250 to 500 kW</td> </tr> <tr> <td>ACQ580-07 cabinet</td> <td>75 to 500 kW</td> </tr> <tr> <td>ACQ580-31 ULH wall-mounted</td> <td>4 to 110 kW</td> </tr> <tr> <td>ACQ580-34 ULH module</td> <td>132 to 355 kW</td> </tr> </table>	ACQ580-01 wall-mounted	0.75 to 75 kW, 3-phase, 230 V 0.75 to 250 kW, 3-phase, 400 V 0.37 to 37 kW, 1-phase, 230 V	ACQ580-04 module	250 to 500 kW	ACQ580-07 cabinet	75 to 500 kW	ACQ580-31 ULH wall-mounted	4 to 110 kW	ACQ580-34 ULH module	132 to 355 kW
ACQ580-01 wall-mounted	0.75 to 75 kW, 3-phase, 230 V 0.75 to 250 kW, 3-phase, 400 V 0.37 to 37 kW, 1-phase, 230 V										
ACQ580-04 module	250 to 500 kW										
ACQ580-07 cabinet	75 to 500 kW										
ACQ580-31 ULH wall-mounted	4 to 110 kW										
ACQ580-34 ULH module	132 to 355 kW										
Frequency	50/60 Hz $\pm 5\%$										
Power factor (-01, -04, -07) (-31, -34)	$\cos\phi = 0.98$ $\cos\phi = 1$										
Efficiency class (IEC 61800-9-2)	IE2										
Efficiency (at nominal power)	98%										
Motor connection											
Voltage	0 to U_N , 3-phase										
Frequency	0 to 500 Hz										
Motor control	Scalar and vector control										
Speed control	Static accuracy: 20% of motor nominal slip Dynamic accuracy: 1% seconds with 100% torque step										
Supported motor types	Asynchronous motor, permanent magnet motor (vector), SynRM (vector)										
Product compliance											
CE											
Ecodesign (EU) 2019/1781											
Low Voltage Directive 2014/35/EU, EN 61800-5-1:2007											
Machinery Directive 2006/42/EC, EN 61800-5-2:2007											
EMC Directive 2014/30/EU, EN 61800-3:2004 + A1:2012											
RoHS directive 2011/65/EU											
Waste electrical and electronic equipment directive (WEEE) 2000/96/EC											
Quality assurance system ISO 9001 and Environmental system RCM, EAC, UL, cUL											
TÜV Nord (safety functions)											
EMC according to EN 61800-3:2004 + A1:2017											
ACQ580-01/-31	Class C2 as standard										
ACQ580-01	Class C1 as integrated option up to 55 kW, IP55 units										
ACQ580-04/-34	Class C3 as standard										
ACQ580-07	Class C2 as standard for powers 75 kW to 250 kW and Class C3 as standard for powers 250 kW to 500 kW										

Harmonic mitigation							
Built-in choke as standard in ACQ580-01 meets the requirements of IEC 61000-3-12: 2011. ACQ580-31 and ACQ580-34 in addition meets the requirements of IEC 61000-3-12: 2011 and G5/4.							
Environmental limits							
Ambient temperature							
Transport	-40 to +70 °C						
Storage	-40 to +70 °C						
Operation area	<table border="1"> <tr> <td>ACQ580-01/-31</td> <td>-15 °C to 50 °C. No frost allowed. From +40 °C to +50 °C with derating 1% per 1 °C.</td> </tr> <tr> <td>ACQ580-04/-34</td> <td>-15 °C to 55 °C. No frost allowed. From +40 °C to +55 °C with derating 1% per 1 °C.</td> </tr> <tr> <td>ACQ580-07</td> <td>0 °C to +50 °C. No frost allowed. From +40 °C to +50 °C with derating 1% per 1 °C.</td> </tr> </table>	ACQ580-01/-31	-15 °C to 50 °C. No frost allowed. From +40 °C to +50 °C with derating 1% per 1 °C.	ACQ580-04/-34	-15 °C to 55 °C. No frost allowed. From +40 °C to +55 °C with derating 1% per 1 °C.	ACQ580-07	0 °C to +50 °C. No frost allowed. From +40 °C to +50 °C with derating 1% per 1 °C.
ACQ580-01/-31	-15 °C to 50 °C. No frost allowed. From +40 °C to +50 °C with derating 1% per 1 °C.						
ACQ580-04/-34	-15 °C to 55 °C. No frost allowed. From +40 °C to +55 °C with derating 1% per 1 °C.						
ACQ580-07	0 °C to +50 °C. No frost allowed. From +40 °C to +50 °C with derating 1% per 1 °C.						
Cooling method							
Air-cooled	Dry clean air						
Altitude							
0 to 1.000 m	Without derating						
1.000 to 4.000 m	With derating of 1%/100 m						
Relative humidity	5 to 95%. no condensation allowed						
Degree of protection	<table border="1"> <tr> <td>ACQ580-01/-31</td> <td>IP21 (UL Type 1) and IP55 (UL Type 12)</td> </tr> <tr> <td>ACQ580-04/-34</td> <td>IP00 (UL Open Type) as standard and IP20 as option</td> </tr> <tr> <td>ACQ580-07</td> <td>IP21 (UL Type 1) as standard, IP42 and IP54 (UL Type 1 and UL Type 12) as option</td> </tr> </table>	ACQ580-01/-31	IP21 (UL Type 1) and IP55 (UL Type 12)	ACQ580-04/-34	IP00 (UL Open Type) as standard and IP20 as option	ACQ580-07	IP21 (UL Type 1) as standard, IP42 and IP54 (UL Type 1 and UL Type 12) as option
ACQ580-01/-31	IP21 (UL Type 1) and IP55 (UL Type 12)						
ACQ580-04/-34	IP00 (UL Open Type) as standard and IP20 as option						
ACQ580-07	IP21 (UL Type 1) as standard, IP42 and IP54 (UL Type 1 and UL Type 12) as option						
Functional safety	Safe torque off (STO according EN 61800-5-2) IEC 61508 ed2: SIL 3, IEC 61511: SIL 3, IEC 62061: SIL CL 3, EN ISO 13849-1: PL e						
Contamination levels	No conductive dust allowed						
Storage	IEC 60721-3-1. Class 1C2 (chemical gases). Class 1S2 (solid particles)*)						
Operation	IEC 60721-3-3. Class 3C2 as standard and 3C3/C4 as option (chemical gases). Class 3S2 (solid particles)*)						
Transportation	IEC 60721-3-2. Class 2C2 (chemical gases). Class 2S2 (solid particles)*)						

*) C = chemically active substances

S = mechanically active substances



How to select a drive?

It is very easy to select the right drive. This is how you build up your own ordering code using the type designation key.

1 Start with identifying your supply voltage.

This tells you what rating table to use.
The ACQ580 supports 200 to 480 V.

2 Choose your motor's nominal current rating

from the ratings table on pages 38-43.

3 Select your drive's type code

from the rating table based on your motor's nominal current rating.

4 Choose your options.

Details about each option begin on page 18.
Add the option codes to the end of the drive's ordering code. Remember to use a "+" before each option code.

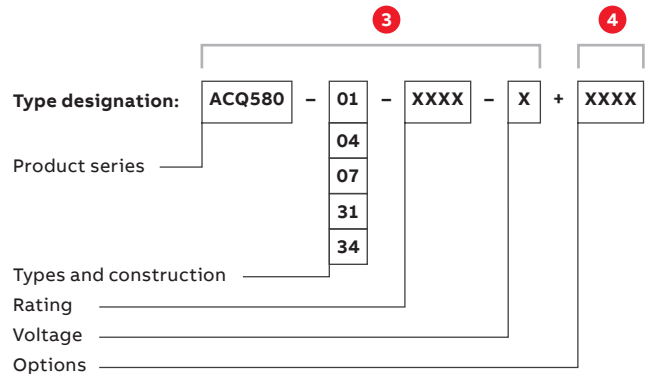

Example configuration:

ACQ580-01-145A-4+B056+J400+L501

Wall-mounted 145 A, 400 V drive in IP55 enclosure with Hand-Off-Auto control panel and internal CMOD-01 input/output option

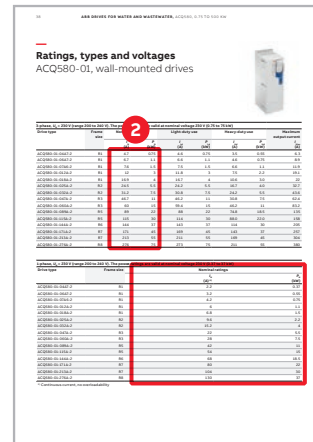

Pages 38-43

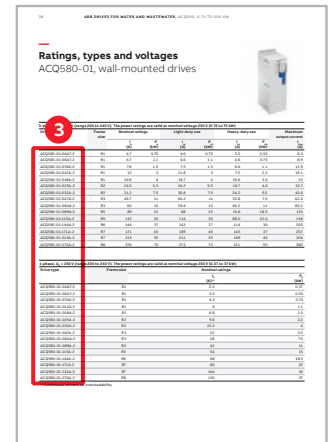

Pages 38-43

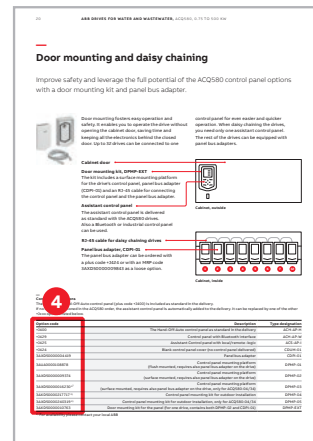

Pages 20-33

Ratings, types and voltages

ACQ580-01, wall-mounted drives



3-phase, $U_N = 230\text{ V}$ (range 200 to 240 V). The power ratings are valid at nominal voltage 230 V (0.75 to 75 kW)

Drive type	Frame size	Nominal ratings		Light-duty use		Heavy-duty use		Maximum output current
		I_N (A)	P_N (kW)	I_{Ld} (A)	P_{Ld} (kW)	I_{Hd} (A)	P_{Hd} (kW)	I_{Max} (A)
ACQ580-01-04A7-2	R1	4.7	0.75	4.6	0.75	3.5	0.55	6.3
ACQ580-01-06A7-2	R1	6.7	1.1	6.6	1.1	4.6	0.75	8.9
ACQ580-01-07A6-2	R1	7.6	1.5	7.5	1.5	6.6	1.1	11.9
ACQ580-01-012A-2	R1	12	3	11.8	3	7.5	2.2	19.1
ACQ580-01-018A-2	R1	16.9	4	16.7	4	10.6	3.0	22
ACQ580-01-025A-2	R2	24.5	5.5	24.2	5.5	16.7	4.0	32.7
ACQ580-01-032A-2	R2	31.2	7.5	30.8	7.5	24.2	5.5	43.6
ACQ580-01-047A-2	R3	46.7	11	46.2	11	30.8	7.5	62.4
ACQ580-01-060A-2	R3	60	15	59.4	15	46.2	11	83.2
ACQ580-01-089A-2	R5	89	22	88	22	74.8	18.5	135
ACQ580-01-115A-2	R5	115	30	114	30	88.0	22.0	158
ACQ580-01-144A-2	R6	144	37	143	37	114	30	205
ACQ580-01-171A-2	R7	171	45	169	45	143	37	257
ACQ580-01-213A-2	R7	213	55	211	55	169	45	304
ACQ580-01-276A-2	R8	276	75	273	75	211	55	380

1-phase, $U_N = 230\text{ V}$ (range 200 to 240 V). The power ratings are valid at nominal voltage 230 V (0.37 to 37 kW)

Drive type	Frame size	Nominal ratings	
		I_N (A) *)	P_N (kW)
ACQ580-01-04A7-2	R1	2.2	0.37
ACQ580-01-06A7-2	R1	3.2	0.55
ACQ580-01-07A6-2	R1	4.2	0.75
ACQ580-01-012A-2	R1	6	1.1
ACQ580-01-018A-2	R1	6.8	1.5
ACQ580-01-025A-2	R2	9.6	2.2
ACQ580-01-032A-2	R2	15.2	4
ACQ580-01-047A-2	R3	22	5.5
ACQ580-01-060A-2	R3	28	7.5
ACQ580-01-089A-2	R5	42	11
ACQ580-01-115A-2	R5	54	15
ACQ580-01-144A-2	R6	68	18.5
ACQ580-01-171A-2	R7	80	22
ACQ580-01-213A-2	R7	104	30
ACQ580-01-276A-2	R8	130	37

*) Continuous current, no overloadability

3-phase, $U_N = 400$ V (range 380 to 480 V). The power ratings are valid at nominal voltage 400 V (0.75 to 250 kW)								
Drive type	Frame size	Nominal ratings		Light-duty use		Heavy-duty use		Maximum output current
		I_N (A)	P_N (kW)	I_{Ld} (A)	P_{Ld} (kW)	I_{Hd} (A)	P_{Hd} (kW)	I_{Max} (A)
ACQ580-01-02A7-4	R1	2.6	0.75	2.5	0.75	1.8	0.55	3.2
ACQ580-01-03A4-4	R1	3.3	1.1	3.1	1.1	2.6	0.75	4.7
ACQ580-01-04A1-4	R1	4	1.5	3.8	1.5	3.3	1.1	5.9
ACQ580-01-05A7-4	R1	5.6	2.2	5.3	2.2	4	1.5	7.2
ACQ580-01-07A3-4	R1	7.2	3	6.8	3	5.6	2.2	10.1
ACQ580-01-09A5-4	R1	9.4	4	8.9	4	7.2	3	13
ACQ580-01-12A7-4	R1	12.6	5.5	12	5.5	9.4	4	14.1
ACQ580-01-018A-4	R2	17	7.5	16.2	7.5	12.6	5.5	22.7
ACQ580-01-026A-4	R2	25	11	23.8	11	17	7.5	30.6
ACQ580-01-033A-4	R3	32	15	30.4	15	24.6	11	44.3
ACQ580-01-039A-4	R3	38	18.5	36.1	18.5	31.6	15	56.9
ACQ580-01-046A-4	R3	45	22	42.8	22	37.7	18.5	67.9
ACQ580-01-062A-4	R4	62	30	58	30	44.6	22	76
ACQ580-01-073A-4	R4	73	37	68.4	37	61	30	104
ACQ580-01-089A-4	R4 v2	89	45	83	45	72	37	122
ACQ580-01-088A-4	R5	88	45	83	45	72	37	122
ACQ580-01-106A-4	R5	106	55	100	55	87	45	148
ACQ580-01-145A-4	R6	145	75	138	75	105	55	178
ACQ580-01-169A-4	R7	169	90	161	90	145	75	247
ACQ580-01-206A-4	R7	206	110	196	110	169	90	287
ACQ580-01-246A-4	R8	246	132	234	132	206	110	350
ACQ580-01-293A-4	R8	293	160	278	160	246*)	132	418
ACQ580-01-363A-4	R9	363	200	345	200	293	160	498
ACQ580-01-430A-4	R9	430	250	400	200	363**)	200	545

Nominal ratings

I_N	Rated current available continuously without overloadability.
P_N	Typical motor power in no-overload use.

Light-duty use

I_{Ld}	Continuous current allowing 110% I_{Ld} for 1 minute every 10 minutes.
P_{Ld}	Typical motor power in light-duty use.

Heavy-duty use

I_{Hd}	Continuous current allowing 150% I_{Hd} for 1 minute every 10 minutes. *) Continuous current allowing 130% I_{Hd} for 1 minute every 10 minutes. **) Continuous current allowing 125% I_{Hd} for 1 minute every 10 minutes.
P_{Hd}	Typical motor power in heavy-duty use.

Maximum output current

I_{max}	Maximum output current. Available for 2 seconds at start.
-----------	---

The ratings apply for the frames R1 to R9 up to +40 °C in enclosure IP class 21/55.

For derating at high altitudes, temperatures or switching frequencies, see the user's HW manual, document code: 3AXD50000035866.

Ratings, types and voltages

ACQ580-04, drive modules



3-phase, $U_N = 400$ V (range 380 to 480 V). The power ratings are valid at nominal voltage 400 V (250 to 500 kW)

Drive type	Frame size	Nominal ratings		Light-duty use		Heavy-duty use		Maximum output current
		I_N (A)	P_N (kW)	I_{Ld} (A)	P_{Ld} (kW)	I_{Hd} (A)	P_{Hd} (kW)	I_{Max} (A)
ACQ580-04-505A-4	R10	505	250	485	250	361	200	560
ACQ580-04-585A-4	R10	585	315	575	315	429	250	730
ACQ580-04-650A-4	R10	650	355	634	355	477	250	730
ACQ580-04-725A-4	R11	725	400	715	400	566	315	1020
ACQ580-04-820A-4	R11	820	450	810	450	625	355	1020
ACQ580-04-880A-4	R11	880	500	865	500	725 *)	400	1100

Nominal ratings

I_N	Rated current available continuously without overloadability.
P_N	Typical motor power in no-overload use.

Light-duty use

I_{Ld}	Continuous current allowing 110% I_{Ld} for 1 minute every 10 minutes.
P_{Ld}	Typical motor power in light-overload use.

Heavy-duty use

I_{Hd}	Continuous current allowing 150% I_{Hd} for 1 minute every 10 minutes. *) Continuous current allowing 140% I_{Hd} for 1 minute every 10 minutes.
P_{Hd}	Typical motor power in heavy-duty use.

Maximum output current

I_{max}	Maximum output current. Available for 2 seconds at start, then as long as allowed by drive temperature.
-----------	---

The ratings apply for the frames R10 to R11 up to +40 °C in enclosure IP class 00/20.

For derating at high altitudes, temperatures or switching frequencies, see the user's HW manual, document code: 3AXD50000048677.

Ratings, types and voltages

ACQ580-07, cabinet-built drives



3-phase, $U_N = 400$ V (range 380 to 480 V). The power ratings are valid at nominal voltage 400 V (75 to 500 kW)

Drive type	Frame size	Nominal ratings		Light-duty use		Heavy-duty use		Maximum output current
		I_N (A)	P_N (kW)	I_{Ld} (A)	P_{Ld} (kW)	I_{Hd} (A)	P_{Hd} (kW)	I_{Max} (A)
ACQ580-07-0145A-4	R6	145	75	138	75	105	55	178
ACQ580-07-0169A-4	R7	169	90	161	90	145	75	247
ACQ580-07-0206A-4	R7	206	110	196	110	169	90	287
ACQ580-07-0246A-4	R8	246	132	234	132	206	110	350
ACQ580-07-0293A-4	R8	293	160	278	160	246**)	132	418
ACQ580-07-0363A-4	R9	363	200	345	200	293	160	498
ACQ580-07-0430A-4	R9	430	250	400	200	363***)	200	545
ACQ580-07-0505A-4	R10	505	250	485	250	361	200	560
ACQ580-07-0585A-4	R10	585	315	575	315	429	250	730
ACQ580-07-0650A-4	R10	650	355	634	355	477	250	730
ACQ580-07-0725A-4	R11	725	400	715	400	566	315	1020
ACQ580-07-0820A-4	R11	820	450	810	450	625	355	1020
ACQ580-07-0880A-4	R11	880	500	865	500	725*)	400	1100

Nominal ratings

I_N	Rated current available continuously without overloadability.
P_N	Typical motor power in no-overload use.

Light-duty use

I_{Ld}	Continuous current allowing 110% I_{Ld} for 1 minute every 10 minutes.
P_{Ld}	Typical motor power in light-duty use.

Heavy-duty use

I_{Hd}	Continuous current allowing 150% I_{Hd} for 1 minute every 10 minutes. *) Continuous current allowing 140% I_{Hd} for 1 minute every 10 minutes. **) Continuous current allowing 130% I_{Hd} for 1 minute every 10 minutes. ***) Continuous current allowing 125% I_{Hd} for 1 minute every 10 minutes.
P_{Hd}	Typical motor power in heavy-duty use.

Maximum output current

I_{max}	Maximum output current. Available for 2 seconds at start, then as long as allowed by drive temperature.
-----------	---

The ratings apply for the frames R6 to R11 up to +40 °C in enclosure IP class 21/42/54.

For derating at high altitudes, temperatures or switching frequencies, see the user's HW manual, document code: 3AXD50000045817.

Ratings, types and voltages

ACQ580-31, ultra-low harmonic drives



3-phase, $U_N = 400$ V (range 380 to 480 V). The power ratings are valid at nominal voltage 400 V (4 to 110 kW)

Drive type	Frame size	Nominal ratings		Light-duty use		Heavy-duty use		Maximum output current
		I_N (A)	P_N (kW)	I_{Ld} (A)	P_{Ld} (kW)	I_{Hd} (A)	P_{Hd} (kW)	I_{Max} (A)
ACQ580-31-09A5-4	R3	9.4	4	8.9	4	7.2	3.0	12.2
ACQ580-31-12A7-4	R3	12.6	5.5	12	5.5	9.4	4.0	16.1
ACQ580-31-018A-4	R3	17	7.5	16	7.5	12.6	5.5	21.4
ACQ580-31-026A-4	R3	25	11	24	11	17	7.5	28.8
ACQ580-31-033A-4	R6	32	15	30	15	25	11	42.5
ACQ580-31-039A-4	R6	38	18.5	36	18.5	32	15	54.4
ACQ580-31-046A-4	R6	45	22	43	22	38	18.5	64.6
ACQ580-31-062A-4	R6	62	30	59	30	45	22	77.5
ACQ580-31-073A-4	R6	73	37	69	37	62	30	105.4
ACQ580-31-088A-4	R6	88	45	84	45	73	37	124.1
ACQ580-31-106A-4	R8	106	55	101	55	88	45	149.6
ACQ580-31-145A-4	R8	145	75	138	75	106	55	181.3
ACQ580-31-169A-4	R8	169	90	161	90	145	75	246.5
ACQ580-31-206A-4	R8	206	110	196	110	169	90	287.3

Nominal ratings

I_N	Rated current available continuously without overloadability.
P_N	Typical motor power in no-overload use.

Light-duty use

I_{Ld}	Continuous current allowing 110% I_{Ld} for 1 minute every 10 minutes.
P_{Ld}	Typical motor power in light-duty use.

Heavy-duty use

I_{Hd}	Continuous current allowing 150% I_{Hd} for 1 minute every 10 minutes. Continuous current allowing 140% I_{Hd} for 1 minute every 10 minutes.
P_{Hd}	Typical motor power in heavy-duty use.

Maximum output current

I_{max}	Maximum output current. Available for 2 seconds at start.
-----------	---

The ratings apply for frames R3, R6 and R8 up to +40 °C in enclosure IP class 21/55.

For derating at higher altitudes, temperatures or switching frequencies, see the HW manual, document code 3AXD50000045935.

Ratings, types and voltages

ACQ580-34, ultra-low harmonic drive modules



3-phase, $U_N = 400$ V (range 380 to 480 V). The power ratings are valid at nominal voltage 400 V (132 to 355 kW)

Drive type	Frame size	Nominal ratings		Light-duty use		Heavy-duty use		Maximum output current
		I_N (A)	P_N (kW)	I_{Ld} (A)	P_{Ld} (kW)	I_{Hd} (A)	P_{Hd} (kW)	I_{Max} (A)
ACQ580-34-246A-4	R11	246	132	234	132	206	110	350.2
ACQ580-34-293A-4	R11	293	160	278	160	246	132	418.2
ACQ580-34-365A-4	R11	365	200	347	200	293	160	498.1
ACQ580-34-442A-4	R11	442	250	420	250	365	200	620.5
ACQ580-34-505A-4	R11	505	250	480	250	365	200	631.3
ACQ580-34-585A-4	R11	585	315	556	315	442	250	751.4
ACQ580-34-650A-4	R11	650	355	618	355	505	250	858.5

Nominal ratings

I_N Rated current available continuously without overloadability at 40 °C.

P_N Typical motor power in no-overload use.

Light-duty use

I_{Ld} Continuous current allowing 110% I_{Ld} for 1 minute every 10 minutes at 40 °C.

P_{Ld} Typical motor power in light-duty use.

Heavy-duty use

I_{Hd} Continuous current allowing 150% I_{Hd} for 1 minute every 10 minutes.
Continuous current allowing 140% I_{Hd} for 1 minute every 10 minutes.

P_{Hd} Typical motor power in heavy-duty use.

Maximum output current

I_{max} Maximum output current. Available for 2 seconds at start.

The ratings apply for frame R11 up to +40 °C in enclosure IP class 00/20.

For derating at higher altitudes, temperatures or switching frequencies, see the HW manual, document code 3AXD50000420035.

Dimensions

ACQ580-01, IP21 and IP55

Frames	Height IP21*/IP55* (mm)	Width IP21/IP55 (mm)	Depth IP21 (mm)	Depth IP55 (mm)	Weight IP21 (kg)	Weight IP55 (kg)
R1	373/403	125/128	223	233	4.6	4.8
R2	473/503	125/128	229	239	6.6	6.8
R3	490	203/206	229	237	11.8	13
R4	636	203	257	265	19	20
R5	732	203	295	320	28.3	29
R6	727	252	369	380	42.4	43
R7	880	284	370	381	54	56
R8	965	300	393	452	69	77
R9	955	380	418	477	97	103

* Front height of the drive with glandbox

ACQ580-04, IP00

Frames	Height (mm)	Width (mm)	Depth (mm)	Weight (kg)
R10	1462	350	529	162
R11	1662	350	529	199

ACQ580-07, IP21, IP42 and IP54

Frames	Height IP21 and IP42 (mm)	Height IP54 (mm)	Width (mm)	Depth IP21 and IP42 (mm)	Depth IP54 (mm)	Weight (kg)
R6	2145	2145	430	673	673	210
R7	2145	2145	430	673	673	220
R8	2145	2145	530	673	682	255
R9	2145	2145	530	673	682	275
R10	2145	2315	830	698	698	410
R11	2145	2315	830	698	698	440

ACQ580-31, IP21 and IP55

Frames	Height (mm)	Width (mm)	Depth IP21 (mm)	Depth IP55 (mm)	Weight IP21 (kg)	Weight IP55 (kg)
R3	495	205	354	360	21.3	21.3
R6	771	252	392	449	61	63
R8	965	300	438	496	112	118

ACQ580-34, IP00

Frames	Height (mm)	Width (mm)	Depth (mm)	Weight (kg)
R11	1722	636.5	504.5	365



Hardware options may affect the dimensions. Please see the corresponding hardware manuals.

Cooling and fuses

Cooling

ACQ580 drives are fitted with variable-speed cooling fans. The speed-controlled fans cool the drive only when needed, reducing overall noise level and energy consumption.

Fuse connection

Standard fuses can be used with the ACQ580 drives. For input fuses, see the table below:

Cooling and fuses

ACQ580-01, wall-mounted drives, 230 V

Cooling air flow and recommended input protection fuses for 200 to 240 V units							
Type designation	Frame size	Cooling air flow			Recommended input protection fuses ***)		
		Typical heat dissipation *)	Air flow	Max. noise level **)	IEC fuses		
					(W)	(m ³ /h)	(dBA)
ACQ580-01-04A7-2	R1	51	43	59	25	170M1563	
ACQ580-01-06A7-2	R1	70	43	59	25	170M1563	
ACQ580-01-07A6-2	R1	80	43	59	25	170M1563	
ACQ580-01-012A-2	R1	142	43	59	25	170M1563	
ACQ580-01-018A-2	R1	228	43	59	25	170M1563	
ACQ580-01-025A-2	R2	253	101	64	40	170M1565	
ACQ580-01-032A-2	R2	358	101	64	40	170M1565	
ACQ580-01-047A-2	R3	527	179	76	63	170M1566	
ACQ580-01-060A-2	R3	775	179	76	63	170M1566	
ACQ580-01-089A-2	R5	876	139	63	125	170M3815	
ACQ580-01-115A-2	R5	1285	139	63	125	170M3815	
ACQ580-01-144A-2	R6	1932	435	67	200	170M3817	
ACQ580-01-171A-2	R7	2000	450	67	250	170M5809	
ACQ580-01-213A-2	R7	2854	450	67	315	170M5810	
ACQ580-01-276A-2	R8	3567	550	65	400	170M6810	

*) Heat dissipation value is a reference for cabinet thermal design not determining Ecodesign ratings.

**) The maximum noise level at full fan speed. When the drive is not operating at full load and at maximum ambient temperature the noise level is lower.

***) For detailed fuse sizes and types, please see the ACQ580-01 HW manuals, document code: 3AXD50000035866

Cooling and fuses

ACQ580-01, wall-mounted drives, 400 V

Cooling air flow and recommended input protection fuses for 380 to 415 V units

Type designation	Frame size	Cooling air flow			Recommended input protection fuses***)			
		Typical heat dissipation*)	Air flow	Max. noise level**)	IEC fuses		UL fuses	
					(A)	Fuse type	(A)	Fuse type
ACQ580-01-02A7-4	R1	69	43	59	4	170M1561	15	JJS-15
ACQ580-01-03A4-4	R1	78	43	59	6	170M1561	15	JJS-15
ACQ580-01-04A1-4	R1	87	43	59	6	170M1561	15	JJS-15
ACQ580-01-05A7-4	R1	113	43	59	10	170M1561	15	JJS-15
ACQ580-01-07A3-4	R1	127	43	59	10	170M1561	15	JJS-15
ACQ580-01-09A5-4	R1	165	43	59	16	170M1561	15	JJS-15
ACQ580-01-12A7-4	R1	237	43	59	16	170M1561	15	JJS-15
ACQ580-01-018A-4	R2	265	101	64	25	170M1563	30	JJS-30
ACQ580-01-026A-4	R2	418	101	64	32	170M1563	30	JJS-30
ACQ580-01-033A-4	R3	514	179	76	40	170M1565	40	JJS-40
ACQ580-01-039A-4	R3	570	179	76	50	170M1565	60	JJS-60
ACQ580-01-046A-4	R3	709	179	76	63	170M1566	60	JJS-60
ACQ580-01-062A-4	R4	957	134	69	80	170M1567	80	JJS-80
ACQ580-01-073A-4	R4	1230	134	69	100	170M1568	100	JJS-100
ACQ580-01-088A-4	R5	1316	139	63	100	170M1569	110	JJS-110
ACQ580-01-106A-4	R5	1589	139	63	125	170M3817	150	JJS-150
ACQ580-01-145A-4	R6	2492	435	67	160	170M3817	200	JJS-200
ACQ580-01-169A-4	R7	2536	450	67	250	170M5809	225	JJS-225
ACQ580-01-206A-4	R7	3391	450	67	315	170M5810	300	JJS-300
ACQ580-01-246A-4	R8	3945	550	65	355	170M5812	350	JJS-350
ACQ580-01-293A-4	R8	5174	550	65	425	170M6812D	400	JJS-400
ACQ580-01-363A-4	R9	6294	1150	68	500	170M6814D	500	JJS-500
ACQ580-01-430A-4	R9	8231	1150	68	630	170M8554D	600	JJS-600

*) Heat dissipation value is a reference for cabinet thermal design not determining Ecodesign ratings.

**) The maximum noise level at full fan speed. When the drive is not operating at full load and at maximum ambient temperature the noise level is lower.

***) For detailed fuse sizes and types, please see the ACQ580-01 HW manuals, document code: 3AXD50000035866

Cooling and fuses

ACQ580-04, drive modules

Cooling air flow and recommended input protection fuses for 380 to 415 V units								
Type designation	Frame size	Cooling air flow			Recommended input protection fuses ***)			
		Typical heat dissipation *)	Air flow	Max. noise level **)	IEC fuses		UL fuses	
					(W)	(m ³ /h)	(dBA)	(A)
ACQ580-04-505A-4	R10	7722	1200	72	800	170M6812D	600	JJS-600
ACQ580-04-585A-4	R10	8754	1200	72	1000	170M6814D	800	A4BY800
ACQ580-04-650A-4	R10	10378	1200	72	1000	170M6814D	800	A4BY800
ACQ580-04-725A-4	R11	10498	1200	72	1250	170M8554D	800	A4BY1000
ACQ580-04-820A-4	R11	12678	1200	72	1600	170M8557D	900	A4BY1000
ACQ580-04-880A-4	R11	14166	1420	72	1600	170M8557D	1000	A4BY1000

*) Heat dissipation value is a reference for cabinet thermal design not determining Ecodesign ratings.

**) The maximum noise level at full fan speed. When the drive is not operating at full load and at maximum ambient temperature the noise level is lower.

***) For detailed fuse sizes and types, please see the ACQ580-04 HW manual 3AXD50000048677

Cooling and fuses

ACQ580-07, cabinet build drives

Cooling air flow and recommended input protection fuses for 380 to 415 V units								
Type designation	Frame size	Cooling air flow			Recommended input protection fuses ***)			
		Typical heat dissipation *)	Air flow	Max. noise level **)	IEC fuses		UL fuses	
					(W)	(m ³ /h)	(dBA)	(A)
ACQ580-07-0145A-4	R6	2487	685	67	250	170M3816D	250	DFJ-250
ACQ580-07-0169A-4	R7	2497	700	67	250	170M3816D	300	DFJ-300
ACQ580-07-0206A-4	R7	3314	700	67	315	170M3817D	300	DFJ-300
ACQ580-07-0246A-4	R8	3806	800	65	400	170M5408	400	170M5408
ACQ580-07-0293A-4	R8	4942	800	65	500	170M5410	500	170M5410
ACQ580-07-0363A-4	R9	5868	1400	68	630	170M6410	630	170M6410
ACQ580-07-0430A-4	R9	7600	1400	68	700	170M6411	700	170M6411
ACQ580-07-0505A-4	R10	8353	2950	72	800	170M6412	800	170M6412
ACQ580-07-0585A-4	R10	9471	2950	72	900	170M6413	900	170M6413
ACQ580-07-0650A-4	R10	11200	2950	72	1000	170M6414	1000	170M6414
ACQ580-07-0725A-4	R11	11386	2950	72	1250	170M6416	1250	170M6416
ACQ580-07-0820A-4	R11	13725	2950	72	1250	170M6416	1250	170M6416
ACQ580-07-0880A-4	R11	15300	3170	72	1400	170M6417	1400	170M6417

*) Heat dissipation value is a reference for cabinet thermal design not determining Ecodesign ratings.

**) The maximum noise level at full fan speed. When the drive is not operating at full load and at maximum ambient temperature the noise level is lower.

***) For detailed fuse sizes and types, please see the ACQ580-07 HW manuals, document code: 3AXD50000045817

Cooling and fuses

ACQ580-31, ultra-low harmonic drives

Cooling air flow and recommended input protection fuses for 380 to 415 V units

Type designation	Frame size	Cooling air flow			Recommended input protection fuses ***)			
		Typical heat dissipation *)	Air flow	Max. noise level **)	IEC fuses		UL fuses	
					(W)	(m ³ /h)	(dBA)	(A)
ACQ580-31-09A5-4	R3	226	361	57	16	170M1558	15	JJS-20
ACQ580-31-12A7-4	R3	329	361	57	16	170M1559	20	JJS-20
ACQ580-31-018A-4	R3	395	361	57	25	170M1561	25	JJS-35
ACQ580-31-026A-4	R3	579	361	57	32	170M1561	35	JJS-35
ACQ580-31-033A-4	R6	625	550	71	40	170M1563	40	JJS-60
ACQ580-31-039A-4	R6	751	550	71	50	170M1565	50	JJS-60
ACQ580-31-046A-4	R6	912	550	71	63	170M1565	60	JJS-60
ACQ580-31-062A-4	R6	1088	550	71	80	170M1566	80	JJS-110
ACQ580-31-073A-4	R6	1502	550	71	100	170M1567	90	JJS-110
ACQ580-31-088A-4	R6	1904	550	71	100	170M1568	110	JJS-110
ACQ580-31-106A-4	R8	1877	800	68	125	170M1569	150	JJS-150
ACQ580-31-145A-4	R8	2963	800	68	160	170M3817	200	JJS-200
ACQ580-31-169A-4	R8	3168	800	68	250	170M5808	225	JJS-225
ACQ580-31-206A-4	R8	3990	800	68	315	170M5809	300	JJS-300

*) Heat dissipation value is a reference for cabinet thermal design not determining Ecodesign ratings.

**) The maximum noise level at full fan speed. When the drive is not operating at full load and at maximum ambient temperature the noise level is lower.

***) For detailed fuse sizes and types, please see the ACQ580-31 HW manual 3AXD5000045935

Cooling and fuses

ACQ580-34, ultra-low harmonic drive modules

Cooling air flow and recommended input protection fuses for 380 to 415 V units

Type designation	Frame size	Cooling air flow			Recommended input protection fuses ***)			
		Typical heat dissipation *)	Air flow	Max. noise level **)	IEC fuses		UL fuses	
					(W)	(m ³ /h)	(dBA)	(A)
ACQ580-34-246A-4	R11	5280	2100	72	400	170M5408	400	170M5008
ACQ580-34-293A-4	R11	6400	2100	72	500	170M5410	500	170M5010
ACQ580-34-365A-4	R11	8000	2100	72	630	170M6410	630	170M6010
ACQ580-34-442A-4	R11	10000	2100	72	700	170M6411	700	170M6011
ACQ580-34-505A-4	R11	10000	2100	72	800	170M6412	800	170M6012
ACQ580-34-585A-4	R11	12600	2100	72	1000	170M6414	1000	–
ACQ580-34-650A-4	R11	14200	2100	72	1000	170M6414	1000	–

*) Heat dissipation value is a reference for cabinet thermal design not determining Ecodesign ratings.

**) The maximum noise level at full fan speed. When the drive is not operating at full load and at maximum ambient temperature the noise level is lower.

***) For detailed fuse sizes and types, please see the ACQ580-34 HW manual 3AXD50000420025

du/dt filters

du/dt filtering suppresses inverter output voltage spikes and rapid voltage changes that stress motor insulation. Additionally, du/dt filtering reduces capacitive leakage currents and high frequency emission of the motor cable as well as high frequency losses and bearing currents in

the motor. The need for du/dt filtering depends on the motor insulation, motor cable type and motor cable length. For information on the required filtering, consult the manufacturer. More information on the du/dt filters can be found in the ACQ580 hardware manual.

du/dt filters

ACQ580-01, wall-mounted drives, 230 V

External du/dt filters	du/dt filter type														
	Unprotected IP00					Protected to IP22						Protected to IP54			
	NOCH0016-60	NOCH0030-60	NOCH0070-60	NOCH0120-60	FOCH0260-70	NOCH0016-62	NOCH0030-62	NOCH0070-62	NOCH0120-62	FOCH0260-72	FOCH0320-52	NOCH0016-65	NOCH0030-65	NOCH0070-65	NOCH0120-65
ACQ580-01-04A7-2	•					•						•			
ACQ580-01-06A7-2	•					•						•			
ACQ580-01-07A6-2	•					•						•			
ACQ580-01-012A-2	•					•						•			
ACQ580-01-018A-2	•					•						•			
ACQ580-01-025A-2		•					•						•		
ACQ580-01-032A-2		•					•						•		
ACQ580-01-047A-2			•					•						•	
ACQ580-01-060A-2			•					•						•	
ACQ580-01-089A-2			•					•						•	
ACQ580-01-115A-2				•					•						•
ACQ580-01-144A-2					•					•					
ACQ580-01-171A-2					•					•					
ACQ580-01-213A-2					•					•					
ACQ580-01-276A-2					•					•					

Sine filters

Sine filters are low-pass filters that suppress the high frequency components of the drive output.

A sine filter consists of single- or three-phase reactors and delta- or star-connected capacitors. The sine filter provides true sinusoidal voltage waveform at the drive output by

suppressing the high frequency voltage components of the drive output. Suppression of the high frequency voltage components is needed when extra-long motor cables are used, there is a step-up transformer between the drive and a motor, or when a drive is installed with an old direct-on-line motor.

ACQ580-01, sine filters

Type designation	Type code Sine filter IP00	Type code Housing case IP21 ^{*)}	$I_{cont. max}$ (A)
3-phase, $U_N = 380...480$ V. The power ratings are valid at nominal voltage 400 V (0.75 to 250 kW).			
ACQ580-01-02A7-4	B84143V0006R231	B84143Q0002R229	2.3
ACQ580-01-03A4-4	B84143V0006R231	B84143Q0002R229	3.1
ACQ580-01-04A1-4	B84143V0006R231	B84143Q0002R229	3.8
ACQ580-01-05A7-4	B84143V0006R231	B84143Q0002R229	5.3
ACQ580-01-07A3-4	B84143V0007R231	B84143Q0004R229	6.9
ACQ580-01-09A5-4	B84143V0012R231	B84143Q0004R229	9.2
ACQ580-01-12A7-4	B84143V0012R231	B84143Q0006R229	12.1
ACQ580-01-018A-4	B84143V0016R229	B84143Q0006R229	16
ACQ580-01-026A-4	B84143V0038R231	B84143Q0008R229	24
ACQ580-01-033A-4	B84143V0038R231	B84143Q0008R229	31
ACQ580-01-039A-4	B84143V0038R231	B84143Q0010R229	37
ACQ580-01-046A-4	B84143V0043R231	B84143Q0010R229	43
ACQ580-01-062A-4	B84143V0064R231	B84143Q0010R229	58
ACQ580-01-073A-4	B84143V0064R231	B84143Q0010R229	64
ACQ580-01-088A-4	B84143V0077R231	B84143Q0012R229	77
ACQ580-01-106A-4	B84143V0091R231	B84143Q0012R229	91
ACQ580-01-145A-4	B84143V0145R231	B84143Q0014R229	126
ACQ580-01-169A-4	B84143V0209R231	B84143Q0014R229	153
ACQ580-01-206A-4	B84143V0209R231	B84143Q0016R229	187
ACQ580-01-246A-4	B84143V0209R231	B84143Q0016R229	209
ACQ580-01-293A-4	B84143V0249R231	B84143Q0018R229	249
ACQ580-01-363A-4	B84143V0390S229	B84143Q0018R229	297
ACQ580-01-430A-4	B84143V0390S229	B84143Q0018R229	352

^{*)} If a sinus filter IP21 is needed please order both type codes for Housing case IP21 and Sine filter IP00.

Example: if a IP21 sine filter is needed for an ACQ580-01-02A7-4 it is necessary to order both B84143V0006R231 and B84143Q0002R229.

Ordering information

How do I build an ordering code?

ACQ580-01

The type designation tells you the specifications and configuration of the drive.

The table shows the primary drive variants.

Sample type code: ACQ580-01-12A7-4+XXXX

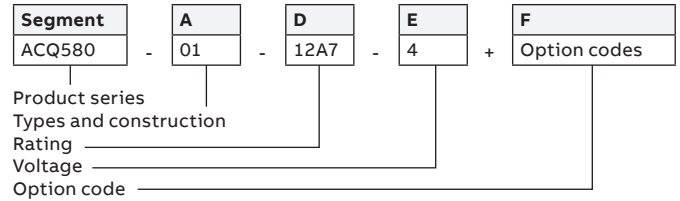

Basic codes

Segment	Option	Description
A	Construction	01 = When no additional options are selected: Wall mounted drive, IP21 (UL Type 1), coated circuit boards, assistant control panel with a USB port, DC choke, embedded Modbus RTU, EMC C2 filter, safe torque off, braking chopper in frames R1, R2, R3, cable lead through entry from the bottom, cable box or the conduit plate with cable entries, quick installation and startup guide (multilingual)
D	Current rating	Refer to the rating table
E	Voltage rating	2 = 200...240 V 4 = 380...480 V

Option codes

Segment	Option	Code	Description
F	Control panel and panel options	+J400	ACH-AP-H Hand-Off-Auto control panel (as standard)
		+OJ400	Removes control panel
		+J424	CDUM-01 Blank control panel cover (no control panel)
		+J425	ACS-AP-I Assistant control panel
		+J429	ACH-AP-W Hand-Off-Auto control panel with a Bluetooth interface
	I/O (one slot available for I/O options)	+L501	CMOD-01 External 24 V AC/DC and digital I/O extension (2×RO and 1×DO)
		+L512	CHDI-01 115/230 V Digital input extension (6×DI and 2×RO)
		+L523	CMOD-02 External 24 V AC/DC and isolated PTC interface
		+L525	CAIO-01 analogue signal extension (3 x AI and 2 x AO)
		+L537	CPTC-02 ATEX-certified PTC interface, Ex II (2) GD and external 24 V. Requires also option +Q971.
		Safety	+Q971
	Fieldbus	+K451	DeviceNet™ (FDNA-01)
		+K454	PROFIBUS® DP (FPBA-01)
+K457		CANopen® (FCAN-01)	
+K458		Modbus RTU (FSCA-01)	
+K475		2-port Ethernet (EtherNet/IP™, Modbus®/TCP, PROFINET®)	
+K490		EtherNet/IP™ (FEIP-21)	
+K491		Modbus®/TCP (FMBT-21)	
+K492		PROFINET® IO (FPNO-21)	
IP enclosure	+B056	IP55 (UL type 12). Factory option, retrofit not possible.	
Construction	+C135	Flange mounting kit. (Only available for 400V IP21 drives)	
	+H358	Cable conduit plate, blank	
	+P944	Drive without cable entry box. Version for cabinet mounting (R5-R9).	
	+F278	Main switch disconnecter (R1-R5)	
	+E223	EMC filter, category C1 for earthed network (R1-R5)	
	+F316	Main switch and EMC filter, category C1 for earthed network (R1-R5)	
	Complementary options	+C218	Conformally coated printed circuit boards to comply with class C4 (IEC60721-3-3:2019/ISO9223) or class 3C3 (IEC60721-3-3:2002)
+C219		Overall drive (R1-R5 frames) to comply with class C4 (IEC60721-3-3:2019/ISO9223) or class 3C3 (IEC60721-3-3:2002), ammonia only	
+P932		Extended warranty up to 60 months	
+P952		European Union Country of origin	

ACQ580-04

The type designation tells you the specifications and configuration of the drive.

The table shows the primary drive variants.

Sample type code: ACQ580-04-505A-4+XXXX

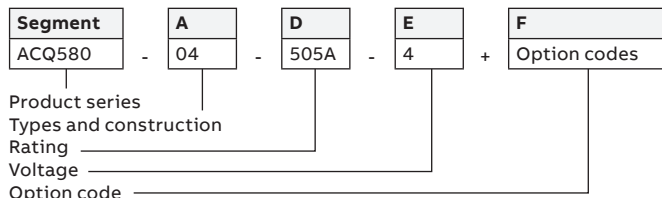

Basic codes		
Segment	Option	Description
A	Construction	04 = When no additional options are selected: Drive module with ramp, coated circuit boards, integrated control unit, assistant control panel with USB port (+J400), control panel door mounting kit (+J410), embedded Modbus RTU, AC choke, common mode filter (+E208), EMC C3 filter (+E210), safe torque off, full size output cable connection, quick installation and startup guide (multilingual)
D	Current rating	Refer to the rating table
E	Voltage rating	4 = 380...480 V

Option codes			
Segment	Option	Code	Description
F	Control panel and panel options	+J400	ACH-AP-H Hand-Off-Auto control panel (as standard)
		+OJ400	No control panel
		+J425	ACS-AP-I Assistant control panel
		+J429	ACH-AP-W Hand-Off-Auto control panel with a Bluetooth interface
	I/O (one slot available for I/O options) (L501, L523 and L512 available as retrofit options)	+L501	External 24 V DC/AC and Digital I/O extension (2xRO and 1xDO) / CMOD-01
		+L512	115/230V Digital input (6xDI and 2xRO) / CHDI-01
		+L523	External 24 V and isolated PTC interface / CMOD-02
		+L525	CAIO-01 analogue signal extension (3 x AI and 2 x AO)
		+L537	ATEX-certified PTC interface, Ex II (2) GD and external 24 V / CPTC-02. Requires also +Q971 option.
	Safety	+Q971	ATEX-certified Safe Disconnection Function, Ex II (2) GD / CPTC-02 (+Q971 option sold only together with +L537 option)
	Fieldbus (One fieldbus adapter supported. Fieldbus adapters available as loose options for retrofit.)	+K451	DeviceNet™ (FDNA-01)
		+K454	PROFIBUS® DP (FPBA-01)
+K457		CANopen® (FCAN-01)	
+K458		Modbus RTU (FSCA-01)	
+K475		2-port Ethernet (EtherNet/IP™, Modbus®/TCP, PROFINET®)	
+K490		EtherNet/IP™ (FEIP-21)	
+K491		Modbus®/TCP (FMBT-21)	
+K492	PROFINET® IO (FPNO-21)		
IP enclosure	+B051	IP20 Finger safe	
Construction	+J410*)	Control panel door mounting kit (+J410 Includes DPMP-03)	
	+H370	Full-size input terminals	
	+P906	External control unit	
	+OH371	No full size output terminals	
	+OH534	No pedestal	
	+OP919	No cabinet installation ramp	
Filters	+E210*)	EMC/RFI-filter, C3, 2 nd Environment, Unrestricted (Earthed & Unearthed Networks)	
	+E208*)	Common mode filter	
Complementary options	+C218	Conformally coated printed circuit boards to comply with class C4 (IEC60721-3-3:2019/ISO9223) or class 3C3 (IEC60721-3-3:2002)	
	+P932	Extended warranty up to 60 months	

*) Included in the standard configuration

ACQ580-07

The type designation tells you the specifications and configuration of the drive.

The table shows the primary drive variants.

Sample type code: ACQ580-07-0145A-4+XXXX

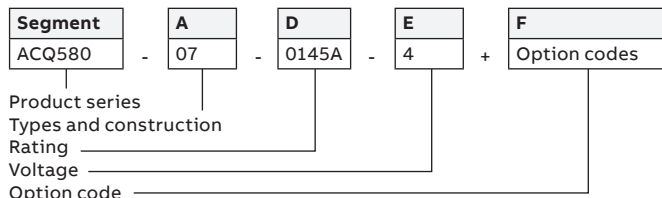

Basic codes			
Segment	Option		Description
A	Construction	07 = When no additional options are selected: Cabinet-built drive, IP21, Main switch and aR fuses, coated circuit boards, DC (R6-R9)/AC (R10-R11) choke, assistant control panel with a USB port, embedded Modbus RTU, EMC filter C2 (R6-R9)/C3 (R10-R11), common mode filter (R10-R11), safe torque-off, bottom entry and exit of cables with cable lead through, documents on USB stick	
D	Current rating		Refer to the rating table
E	Voltage rating		4 = 380...480 V
Option codes			
Segment	Option	Code	Description
F	Control panel and panel options	+J429	ACH-AP-W Hand-Off-Auto control panel with a Bluetooth interface
	I/O (one slot available for I/O options)	+L501	External 24 V DC/AC and Digital I/O extension (2xRO and 1xDO)
		+L504	Additional I/O-Terminal Block
		+xL506	Pt100 relay (x = 1, 2, 3, or 5 pcs... ie 3L506)
		+L512	115/230V Digital input (6xDI and 2xRO)
		+L523	External 24 V and isolated PTC interface
		+L525	CAIO-01 analogue signal extension (3 x AI and 2 x AO)
		+L537	ATEX-certified thermistor protection module, Ex II (2) GD (requires ATEX-certified Safe Disconnection Function, Ex II (2) GD, add +Q971 to code)
	Safety	+Q971	ATEX-certified Safe Disconnection Function, Ex II (2) GD (+Q971 option sold only together with +L537 option. Not available with +Q951)
		+Q951	Safety option of emergency stop where Main breaker is opened during emergency
		+Q963	Safety option of emergency stop where main breaker is not opened during emergency
	Fieldbus (One fieldbus adapter supported. Note: Embedded fieldbus interface can't be used at the same time with fieldbus adapter. Fieldbus adapters available as loose options for retrofit.)	+K451	DeviceNet™ (FDNA-01)
		+K454	PROFIBUS® DP (FPBA-01)
		+K457	CANopen® (FCAN-01)
		+K458	Modbus RTU (FSCA-01)
+K475		2-port Ethernet (EtherNet/IP™, Modbus®/TCP, PROFINET®)	
Fieldbus adapters available as loose options for retrofit.)	+K490	EtherNet/IP™ (FEIP-21)	
	+K491	Modbus®/TCP (FMBT-21)	
	+K492	PROFINET® IO (FPNO-21)	
ABB Ability™ Condiion Monitoring for drives	+K496	NETA-21 Wired remote monitoring system	
IP enclosure	+B054	IP42 enclosure class(Type 1 in case of UL certification)	
	+B055	IP54 enclosure class(Type 12 in case of UL certification)	
Construction	+C129	Cabinet drive is UL listed	
	+C180	Seismic design	
Filters, contactors, circuit breakers	+E205	Du/dt filter	
	+E208	Common mode filter (as a default for R10-R11)	
	+F250	Line contactor	
	+F289	Molded case circuit breaker (UL listed, requires C129 option)	

Option codes			
Segment	Option	Code	Description
F	Cabling	+H351	Top entry (additional channel for frames R6-R9, +125 mm the drive cabinet width) Top entry through roof (frames R10-R11)
		+H353	Top exit (additional channel for frames R6-R9, +125mm the drive cabinet width) Top exit (frames R10-R11) – additional 150 mm channel
		+H358	Cable conduit entry (Default in US, anywhere else specify in order)
		+C164	Plinth 100 mm (separate in package)
		+C179	Plinth 200 mm (separate in package)
		Cabinet options	+C128
	+C130		Channeled air outlet
	+C196		Empty cabinet 400 mm on right side
	+C197		Empty cabinet 600 mm on right side
	+C198		Empty cabinet 800 mm on right side
	+C199		Empty cabinet 400 mm on left side
	+C200		Empty cabinet 600 mm on left side
	+C201		Empty cabinet 800 mm on left side
	+G300		Cabinet heater (External supply)
	+G313		Output for motor heater
	+G327		Ready Pilot light, white
	+G307		Terminals for external control voltage
	+G328		Run Pilot light, green
	+G329		Fault Pilot light, red
	Starter for auxiliary motor fan	+M600	1...1.6 A; 1PC-s, dimensioned by fan size, Includes protective devices
		+M601	1.6...2.5 A; 1PC-s, dimensioned by fan size, Includes protective devices
		+M602	2.5...4 A; 1PC-s, dimensioned by fan size, Includes protective devices
		+M603	4...6.3 A; 1PC-s, dimensioned by fan size, Includes protective devices
		+M604	6.3...10 A; 1PC-s, dimensioned by fan size, Includes protective devices
		+M605	10...16 A; 1PC-s, dimensioned by fan size, Includes protective devices
	Complementary options	+P932	Extended warranty up to 60 months
	Specialities	+C218	Conformally coated printed circuit boards to comply with class C4 (IEC60721-3-3:2019/ISO9223) or class 3C3 (IEC60721-3-3:2002)
+P912		Seaworthy Packing (R10, R11: High Cube (HC) container required for reshipping)	

ACQ580-31

The type designation tells you the specifications and configuration of the drive.

The table shows the primary drive variants.

Sample type code: ACQ580-31-026A-4+xxxx

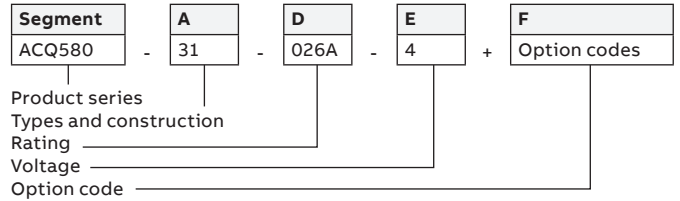

Basic codes			
Segment	Option		Description
A	Construction		31 = When no additional options are selected: Ultra low harmonic wall mounted drive, IP21 (UL Type 1), coated circuit boards, assistant control panel with a USB port, embedded Modbus RTU, active front end with LCL filter, common mode filter, EMC C2 filter, safe torque off, cable lead through entry from the bottom, cable box or the conduit plate with cable entries, quick installation and startup guide (multilingual)
D	Current rating		Refer to the rating table
E	Voltage rating		4 = 380...480 V
Option codes			
Segment	Option	Code	Description
F	Control panel and panel options	+J400	ACH-AP-H Hand-Off-Auto control panel (as standard)
		+J424	CDUM-01 Blank control panel cover (no control panel)
		+J425	ACS-AP-I Assistant control panel
		+J429	ACH-AP-W Hand-Off-Auto control panel with a Bluetooth interface
	I/O (one slot available for I/O options)	+L501	CMOD-01 External 24 V AC/DC and digital I/O extension (2×RO and 1×DO)
		+L512	CHDI-01 115/230 V Digital input extension (6×DI and 2×RO)
		+L523	CMOD-02 External 24 V AC/DC and isolated PTC interface
		+L525	CAIO-01 analogue signal extension (3 x AI and 2 x AO)
		+L537	CPTC-02 ATEX-certified PTC interface, Ex II (2) GD and external 24 V. Requires also option +Q971.
	Safety	+Q971	ATEX-certified Safe Disconnection Function, Ex II (2) GD. Sold only with option +L537.
	Fieldbus	+K451	DeviceNet™ (FDNA-01)
		+K454	PROFIBUS® DP (FPBA-01)
		+K457	CANopen® (FCAN-01)
		+K458	Modbus RTU (FSCA-01)
+K475		2-port Ethernet (EtherNet/IP™, Modbus®/TCP, PROFINET®)	
+K490		EtherNet/IP™ (FEIP-21)	
+K491		Modbus®/TCP (FMBT-21)	
+K492	PROFINET® IO (FPNO-21)		
IP enclosure	+B056	IP55 (UL type 12). Factory option, retrofit not possible.	
Construction	+C135	Flange mounting kit. (Only available for IP21 drives)	
	+H358	Cable conduit plate, blank	
Complementary options	+C218	Conformally coated printed circuit boards to comply with class C4 (IEC60721-3-3:2019/ISO9223) or class 3C3 (IEC60721-3-3:2002)	
	+P932	Extended warranty up to 60 months	

ACQ580-34

The type designation tells you the specifications and configuration of the drive.

The table shows the primary drive variants.

Sample type code: ACQ580-34-293A-4+XXXX

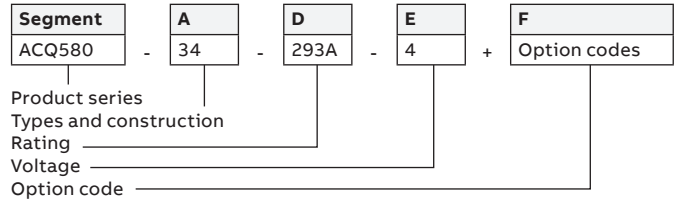

Basic codes			
Segment	Option		Description
A	Construction		34 = When no additional options are selected: Ultra low harmonic drive module with ramp, IP00 (UL Type Open), coated circuit boards, integrated control unit, assistant control panel with a USB port (+J400), control panel door mounting kit (+J410), embedded Modbus RTU, active front end with LCL filter, common mode filter (+E208), EMC C3 filter (+E210), safe torque off, full size output cable connection, quick installation and startup guide (multilingual)
D	Current rating		Refer to the rating table
E	Voltage rating		4 = 380...480 V
Option codes			
Segment	Option	Code	Description
F	Control panel and panel options	+J400	ACH-AP-H Hand-Off-Auto control panel (as standard)
		+J425	ACS-AP-I Assistant control panel
		+J429	ACH-AP-W Hand-Off-Auto control panel with a Bluetooth interface
	I/O (one slot available for I/O options) (L501, L523 and L512 available as retrofit options)	+L501	External 24 V DC/AC and Digital I/O extension (2xRO and 1xDO) / CMOD-01
		+L512	115/230V Digital input (6xDI and 2xRO) / CHDI-01
		+L523	External 24 V and isolated PTC interface / CMOD-02
		+L525	CAIO-01 analogue signal extension (3 x AI and 2 x AO)
		+L537	ATEX-certified PTC interface, Ex II (2) GD and external 24 V / CPTC-02. Requires also +Q971 option.
	Safety	+Q971	ATEX-certified Safe Disconnection Function, Ex II (2) GD / CPTC-02 (+Q971 option sold only together with +L537 option)
	Fieldbus (One fieldbus adapter supported. Fieldbus adapters available as loose options for retrofit.)	+K451	DeviceNet™ (FDNA-01)
		+K454	PROFIBUS® DP (FPBA-01)
		+K457	CANopen® (FCAN-01)
		+K458	Modbus RTU (FSCA-01)
+K475		2-port Ethernet (EtherNet/IP™, Modbus®/TCP, PROFINET®)	
+K490		EtherNet/IP™ (FEIP-21)	
+K491		Modbus®/TCP (FMBT-21)	
+K492	PROFINET® IO (FPNO-21)		
IP enclosure	+B051	IP20 Finger safe	
Construction	+J410 *)	Control panel door mounting kit (+J410 Includes DPMP-03)	
	+J424	CDUM-01 Blank control panel cover (no control panel)	
	+H370	Full-size input terminals	
	+P906	External control unit	
	+OH371	No full size output terminals	
	+OP919	No cabinet installation ramp	
Complementary options	+C218	Conformally coated printed circuit boards to comply with class C4 (IEC60721-3-3:2019/ISO9223) or class 3C3 (IEC60721-3-3:2002)	
	+P932	Extended warranty up to 60 months	

*) Included in the standard configuration

Choose the right motor for your application

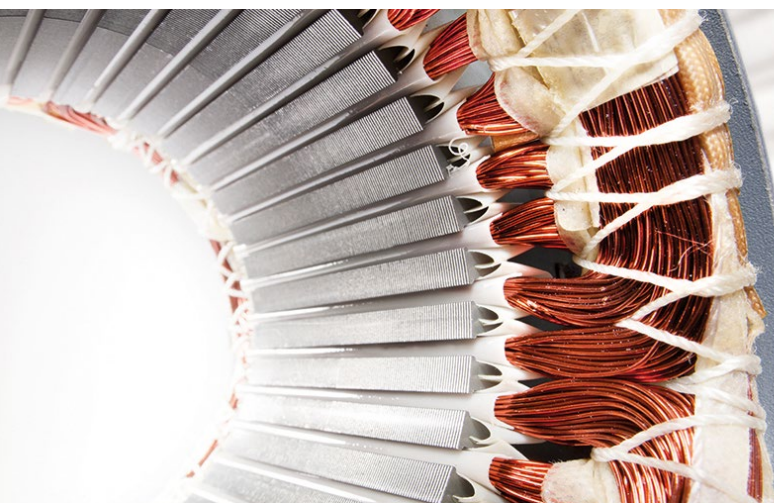

Choose the best motor for your application. A natural match for induction motors, ABB drives for water and wastewater can also control high-efficiency motors such as permanent magnet or synchronous reluctance motors for greater efficiency.

Induction motors, the industry workhorse

Pair the ACQ580 with an induction motor (IM) for simple and reliable operation in many water applications and in a wide range of environments. Further simplifying setup, the ACQ580 drives can be integrated with virtually any type of IM by entering the nameplate motor data only.



Permanent magnet motors for smooth operation

ABB has the software, hardware and application knowledge to support PM motor technology. PM technology offers users high efficiency across the speed range and customized housing for applications in water and wastewater applications, as well as eliminated need for gearboxes in low speed / high torque applications that can be seen in pumping.

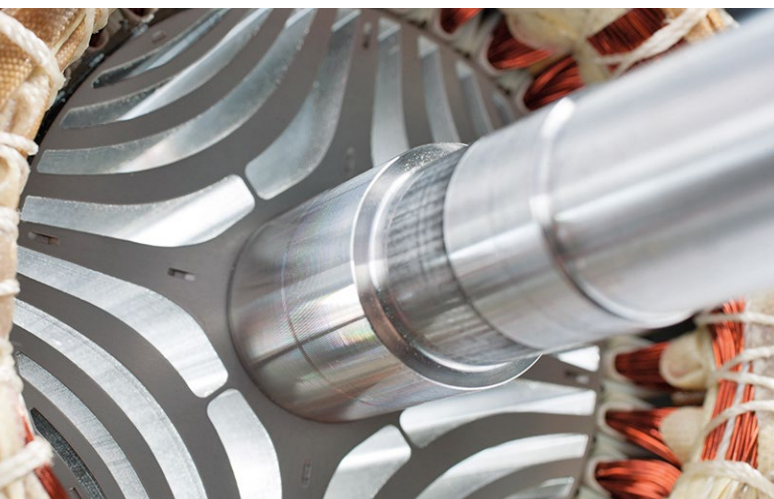

IE5 SynRM for optimized energy efficiency

Combining ABB's drive control technology with our synchronous reluctance motors will give you a motor and a drive package that ensures high energy efficiency, reduces motor temperatures, and provides a significant reduction in motor noise. The key is in the efficiency-optimized rotor design of our SynRM motors.

Synchronous reluctance motors

Ultimate efficiency and reliability to optimize your cost of ownership



Traditional induction motor



IE5 SynRM motor

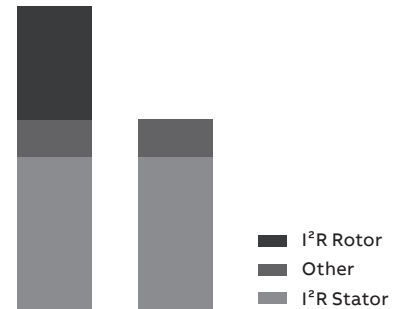

Losses IM vs SynRM

Innovation inside

The idea is simple. Take a conventional, proven stator technology and an innovative rotor design. Then combine them with an ABB general purpose drive loaded with software with versatile features. Finally, optimize the whole package for applications such as compressors, conveyors, mixers, pumps, centrifuges, fans and many other variable and constant torque applications.

Magnet-free design

Synchronous reluctance technology combines the performance of a permanent magnet motor with the simplicity and service-friendliness of an induction motor. The new rotor has neither magnets nor windings, and suffers virtually no power losses. And because there are no magnetic forces in the rotor, maintenance is as straightforward as with induction motors.

Superior reliability to minimize the cost of not running

International Efficiency class IE5 synchronous reluctance motors (SynRM) have very low winding temperatures, which increases the reliability and lifetime of the winding. More importantly, a cool synchronous reluctance rotor means significantly lower bearing temperatures – an important factor because bearing failures cause about 70 percent of unplanned motor outages.

Perfect for retrofits

The SynRM package is a perfect solution for motor retrofits. The IE5 SynRM is the same size as an IE3 induction motor, eliminating the need for mechanical modifications. The increased efficiency will, on the other hand, reduce the payback time of the investment.

Full motor control, down to zero speed

Many processes require accurate speed control. SynRM always runs at reference speed with practically no error, without an encoder. Even the best slip compensation systems in an induction motor inverter will never match the precision of SynRM. Sometimes your application may require you to run your motor at slow speeds. If you are using SynRM and your drive cannot provide the necessary torque, it may trip. ABB drives provide full control and torque down to zero speed, even without speed sensors.

For all applications

This is important if you are planning on using the motor with applications other than quadratic torque applications like pumps and fans. Our drives provide full SynRM motor control for constant torque applications such as extruders, conveyors and wire drawing machines.

SynRM technology	Benefit
Higher efficiency IE5	Lowest energy consumption
No rare earth metals	Environmental sustainability
Magnet-free rotor	Easy service
Lower winding and bearing temperatures	Longer life time, extended service intervals
Better controllability	Accurate speed and torque control
Lower noise level	Better working and living environment
Same size with IE3	Perfect for retrofits



Selection guide

IE5 synchronous reluctance motors

This table presents performance data for IE5 SynRM motor and ACQ580 drive package. Variant codes and construction details are based on the M3BP motor, protection IP55, cooling IC 411, insulation class F, temperature rise class B.

Output (kW)	Motor type *)	Product code	Motor efficiency (%)	Motor nominal current (A)	Motor nominal torque (Nm)	Motor weight (kg)	Matched ACQ580-01 drive	Package efficiency** IES at nominal point (Pn) (%)	PDS*** IES2 efficiency class low limit (%)	Package efficiency above IES2 efficiency class low limit (%)	Drive frame size
3000 RPM / 100 Hz			400 V network								
5.5	M3AL132SMA4	3GAL132217---C	92.8	12.1	17.5	41	ACQ580-01-12A7-4	88.9	82.5	7.8	R1
7.5	M3AL132SMB4	3GAL132227---C	93.1	16.5	23.9	41	ACQ580-01-018A-4	90.5	83.9	7.9	R2
11	M3AL132SMC4	3GAL132237---C	94.0	24.5	35.0	47	ACQ580-01-026A-4	91.2	85.3	6.9	R2
11	M3BL160MLA4	3GBL162417---C	93.7	25.6	35.0	133	ACQ580-01-026A-4	91.5	85.3	7.3	R2
15	M3AL132SMD4	3GAL132247---C	94.1	32.9	47.8	47	ACQ580-01-039A-4	91.6	86.2	6.3	R3
15	M3BL160MLB4	3GBL162427---C	95.1	34.6	48.0	133	ACQ580-01-039A-4	92.3	86.2	7.1	R3
18.5	M3BL160MLC4	3GBL162437---C	94.6	43.3	59.0	133	ACQ580-01-046A-4	91.9	86.9	5.8	R3
22	M3BL180MLA4	3GBL182417---C	94.8	49.5	70.0	160	ACQ580-01-062A-4	92.2	87.3	5.6	R4
30	M3BL200MLA4	3GBL202417---C	94.6	68.3	95.0	259	ACQ580-01-073A-4	92.1	88.1	4.5	R4
37	M3BL200MLB4	3GBL202427---C	95.5	84.5	118.0	259	ACQ580-01-088A-4	93.8	88.6	5.9	R5
45	M3BL225SMA4	3GBL222217---C	96.0	101.0	143.0	282	ACQ580-01-106A-4	93.7	89.0	5.3	R5
55	M3BL225SMF4	3GBL222267---C	95.3	124.0	175.0	282	ACQ580-01-145A-4	92.6	89.4	3.6	R6
1500 RPM / 50 Hz											
5.5	M3AL132SMA4	3GAL32213---C	93.7	11.7	35.0	63	ACQ580-01-12A7-4	91.5	82.5	10.9	R1
7.5	M3AL132SMB4	3GAL132223---C	93.7	15.7	47.8	63	ACQ580-01-018A-4	91.1	83.9	8.6	R2
11	M3AL132SMC4	3GAL132233---C	94.2	23.8	70.0	69	ACQ580-01-026A-4	91.6	85.3	7.4	R2
11	M3BL160MLA4	3GBL162413---C	94.0	24.2	70.0	160	ACQ580-01-026A-4	92.1	85.3	8.0	R2
15	M3BL160MLB4	3GBL62423---C	94.8	32.1	95.0	177	ACQ580-01-039A-4	92.6	86.2	7.4	R3
18.5	M3BL180MLA4	3GBL182413---C	94.3	40.3	118.0	177	ACQ580-01-046A-4	92.1	86.9	6.0	R3
22	M3BL200MLF4	3GBL202463---C	95.7	48.1	140.0	304	ACQ580-01-062A-4	93.5	87.3	7.1	R4
30	M3BL200MLA4	3GBL202413---C	95.3	66.1	191.0	304	ACQ580-01-073A-4	93.1	88.1	5.7	R4
37	M3BL250SMF4	3GBL252263---C	95.5	83.0	236.0	428	ACQ580-01-088A-4	93.6	88.6	5.6	R5
45	M3BL250SMG4	3GBL252273---C	95.6	98.9	286.0	428	ACQ580-01-106A-4	93.9	89.0	4.6	R5
55	M3BL250SMA4	3GBL252213---C	95.6	119.0	350.0	454	ACQ580-01-145A-4	93.6	89.4	5.0	R6
75	M3BL280SMA4	3GBL282213---C	96.1	166.0	478.0	639	ACQ580-01-206A-4	93.9	90.0	4.0	R7
90	M3BL280SMB4	3GBL82223---C	96.5	199.0	573.0	639	ACQ580-01-206A-4	93.9	90.2	4.1	R7
110	M3BL280SMC4	3GBL282233---C	96.7	241.0	699.0	697	ACQ580-01-246A-4	94.7	90.5	4.6	R8
110	M3BL315SMA4	3GBL312213---C	96.8	243.0	702.0	873	ACQ580-01-246A-4	94.8	90.5	4.8	R8
132	M3BL315SMB4	3GBL312223---C	96.8	290.0	842.0	925	ACQ580-01-293A-4	94.3	90.7	4.0	R8
160	M3BL315SMC4	3GBL312233---C	97.1	343.0	1018.0	965	ACQ580-01-363A-4	94.7	90.9	4.2	R9
200	M3BL315MLA4	3GBL312413---C	97.2	428.0	1272.0	1116	ACQ580-01-430A-4	94.7	91.1	4.0	R9
250	M3BL315LKA4	3GBL312813---C	97.1	552.0	1591.0	1357	ACQ580-04-585A-4	94.5	91.2	3.7	R9
315	M3BL315LKC4	3GBL312833---C	97.2	662.0	2006.0	1533	ACQ580-04-650A-4	94.6	91.2	3.8	R9
1000 RPM / 33 Hz											
7.5	M3BL160MLA4	3GBL162412---C	93.1	16.5	72.0	160	ACQ580-01-018A-4	91.0	83.9	8.4	R2
11	M3BL160MLB4	3GBL162422---C	93.7	24.1	105	177	ACQ580-01-026A-4	91.3	85.3	7.0	R2
15	M3BL200MLF4	3GBL202462---C	94.7	32.4	143	282	ACQ580-01-039A-4	92.5	86.2	7.3	R3
18.5	M3BL200MLA4	3GBL202412---C	95.2	39.9	177	304	ACQ580-01-046A-4	92.7	86.9	6.7	R3
22	M3BL200MLB4	3GBL202422---C	95.0	47.0	210	304	ACQ580-01-062A-4	92.9	87.3	6.4	R4
30	M3BL250SMF4	3GBL252262---C	95.3	67.2	286	391	ACQ580-01-073A-4	92.6	88.1	5.1	R4
37	M3BL250SMA4	3GBL252212---C	95.6	80.5	353	428	ACQ580-01-088A-4	93.4	88.6	5.4	R5
45	M3BL280SMA4	3GBL282212---C	96.2	98.6	430	639	ACQ580-01-106A-4	94.0	89.0	5.6	R5
55	M3BL280SMB4	3GBL282222---C	96.0	119	526	639	ACQ580-01-145A-4	93.8	89.4	4.9	R6
75	M3BL280SMC4	3GBL282232---C	96.2	160	715	697	ACQ580-01-206A-4	94.1	90.0	4.5	R7
75	M3BL315SMA4	3GBL312212---C	96.5	164	717	873	ACQ580-01-206A-4	94.2	90.0	4.7	R7
90	M3BL315SMB4	3GBL312222---C	96.8	199	859	925	ACQ580-01-206A-4	94.2	90.2	4.5	R7
110	M3BL315SMC4	3GBL312232---C	96.8	241	1051	965	ACQ580-01-246A-4	94.4	90.5	4.3	R8
132	M3BL315MLA4	3GBL312412---C	97.1	278	1261	1116	ACQ580-01-293A-4	94.6	90.7	4.3	R8
160	M3BL315LKA4	3GBL312812---C	97.1	341	1527	1357	ACQ580-01-363A-4	94.7	90.9	4.1	R9
200	M3BL315LKC4	3GBL312832---C	97.3	416	1910	1533	ACQ580-01-430A-4	94.7	91.1	4.0	R9

*) Motor type M3AL = aluminum motor frame
Motor type M3BL = cast iron motor frame

**) Calculated package efficiency values for ACQ580-01
***) PDS = Power Drive System

ABB automation products



AC500

ABB's powerful flagship PLC offering provides wide range of performance levels and scalability within a single simple concept where most competitors require multiple product ranges to deliver similar functionality.



AC500-S

A PLC based modular automation solution that makes it easier than before to mix and match standard and safety I/O modules to expertly meet your safety requirements in all functional safety applications. "Extreme conditions" version is also offered.



AC500-eCo

Meets the cost-effective demands of the small PLC market while offering total inter-operability with the core AC500 range. Web server, FTP server and Modbus-TCP for all Ethernet versions. A Pulse Train Out-put module is available for multi-axis positioning.



AC500-XC

"Extreme conditions" modules with extended operating temperature, immunity to vibration and hazardous gases. for use at high altitudes, in humid conditions. etc. It replaces expensive cabinets with its built-in protection against dirt, water, gases and dust.



Water library package

ABB's water library is compatible with the AC500 series PLC's. They provide advance pumping functions, data logging, remote access and reliable data communication. The libraries ensure saved engineering time and costs as well as ease of use with fast programming possibilities.

Programmability

Automation Builder integrates the engineering and maintenance for PLC, drives, motion, HMI and robotics. It complies with the IEC 61131-3 standard offering all five IEC programming languages for PLC and drive configuration. Automation Builder supports a number of languages and comes with new libraries. FTP functions, SMTP, SNMP, smart diagnostics and debugging capabilities.



Control panels

Our control panels offer a wide range of touchscreen graphical displays from 3.5" up to 15". They are provided with user-friendly configuration software that enables tailor made customized HMI solutions. Rich sets of graphical symbols and the relevant drivers for ABB automation products are provided. Control panels for visualization of AC500 web server applications are available.



Softstarters

ABB's softstarters increase a motor's lifetime by protecting it from electrical stresses. With everything that you need in one unit, from bypass contactor to overload protection, a single Softstarter makes for a compact and complete starting solution.



Our service expertise, your advantage

ABB Motion Services helps customers around the globe by maximizing uptime, extending product life cycle, and enhancing the performance and energy efficiency of electrical motion solutions. We enable innovation and success through digitalization by securely connecting and monitoring our customers' motors and drives, increasing operational uptime, and improving efficiency. We make the difference for our customers and partners every day by keeping their operations running profitably, safely and reliably.

With a service offering tailored to your needs, ABB Motion Services maximizes the uptime and extends the life cycle of your electrical motion solutions, while optimizing their performance and maximizing your energy efficiency gains throughout the entire lifetime of your applications. We help to keep your applications turning profitably, safely, and reliably.

Digitalization enables new smart and secured ways to prevent unexpected downtime while optimizing the operation and maintenance of your assets. We securely connect and monitor your motors, drives or your entire powertrain to our easy to use cloud service solutions. Connecting your applications also gives you access to our in-depth service domain expertise.

We quickly respond to your service needs. Together with our partners, local field service experts, and service workshop networks, we provide and install original spare parts to help resolve any issues and minimize the impact of unexpected disruptions.

Our tailored to your needs service offerings and digital solutions will enable you to unlock new possibilities. Not only are we your premier supplier of motion equipment, we are your trusted partner and advisor offering support throughout the entire life cycle of your assets. We ensure your operations run profitably, safely and reliably and continue to drive real world results, now and in the future. Our service teams work with you, delivering the expertise needed to keep your world turning while saving energy every day.



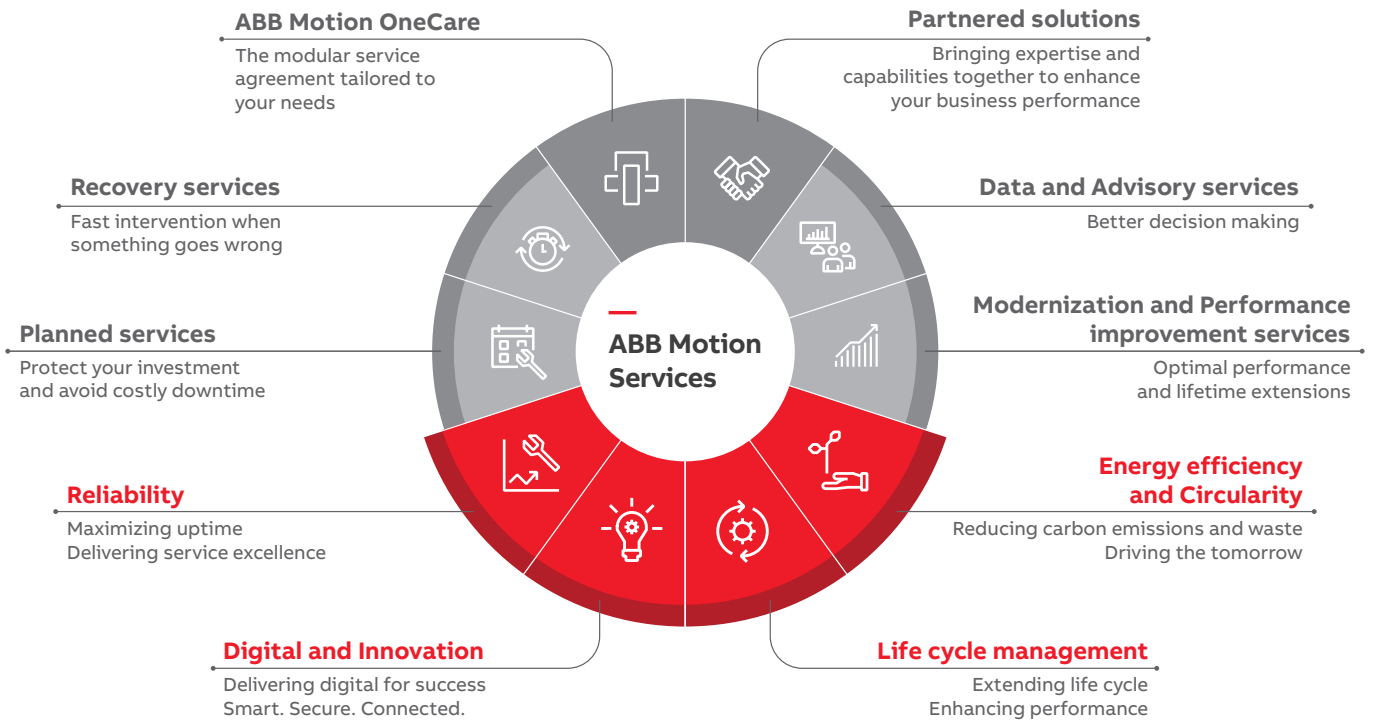

OUR EXPERTISE
YOUR ADVANTAGE



ABB Ability™ Digital Powertrain

Condition monitoring for drives

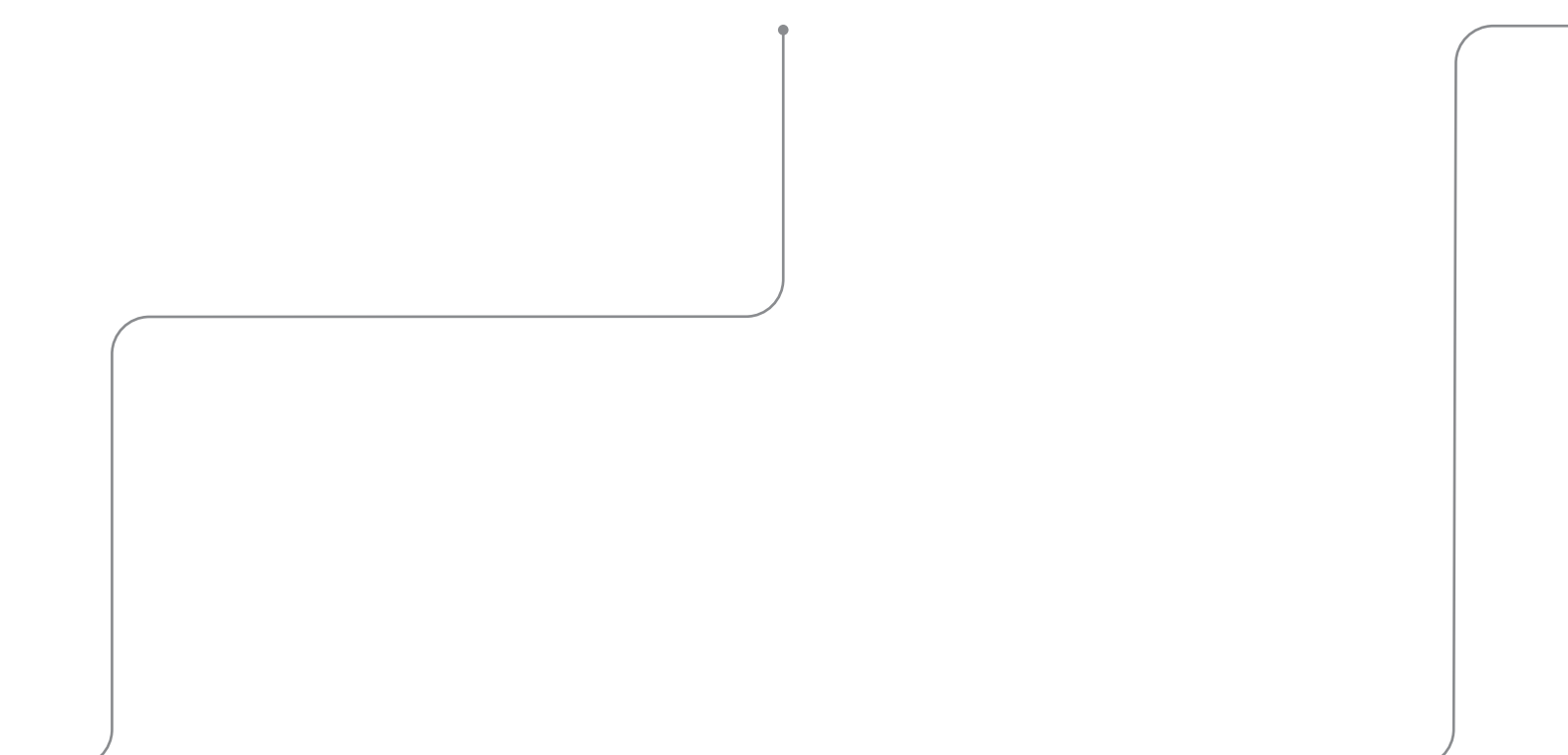

Accurate, real-time information about powertrain events. When you have the facts, you can make the right decisions.

Condition Monitoring gives you fact-based insight into your powertrain assets, such as drives and motors, via KPIs and signal data, to identify irregularities before they become problems. This helps you make proactive decisions, built on real-time information – and saves you money!

The service can be tailored to fit your needs

Our standard package gives you industry leading monitoring capabilities – whether you want to view the drive status through ABB's Internet portal or integrate this data with your existing monitoring systems.

The standard package includes the following services:

- Condition Monitoring
- Alarm Management
- Asset Health
- Team Support
- Backup Management

The standard package can be supplemented with optional services:

- Offline Data Collection
- Expert Reports
- Remote Assistance
- Condition monitoring of your entire powertrain



Solid fact-based decision making

Get the facts, and the history, to help run your operations better and more safely.



Always stay one step ahead of problems

Recognize early signs of possible failures and assess the risks, before they turn into serious operational issues.



Find the root cause of process issues

Remotely access data from ABB drives built-in sensors to track the cause of problems. Get back to smooth operation quickly with data back-ups.



Remotely analyze and optimize drives

Get critical drive information anywhere anytime – even in difficult to access sites, or when a site visit is impossible.

NETA-21

NETA-21 connects the drive to the cloud via the Internet or local Ethernet network.

- The module comes with a built-in web server and requires no Flash/Java plugins
- In the absence of a customer local area network, it can be connected via a mobile network router (either Ethernet or USB network adapter)
- One module can be connected to several drives at the same time

NETA-21	Ordering code	Description
	3AUA0000094517	2 x panel bus interface
		max. 9 drives
		2 x Ethernet interface
		SD memory card

RMDE reliability monitoring device

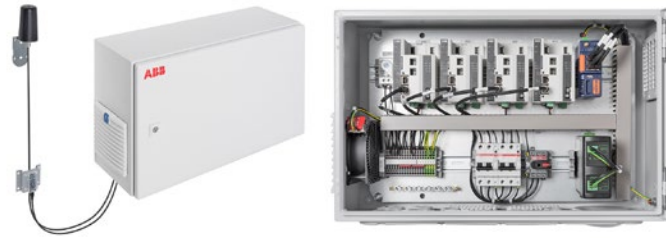

The RMDE reliability monitoring device facilitates the installation of the connectivity device (NETA-21) on drives that are already installed.

- The RMDE device can contain two or four NETA modules and can connect up to 18 or even 36 drives
- The cabinet consists of the NETA-21 connectivity devices, a modem and environmental sensors that enable the collection of measured ambient temperature and humidity values
- The cabinet includes a compact IP54 enclosure, making it suitable even for harsh environments

Customers can configure powertrains and customize the digital service plan



ABB Drives Life Cycle Management

A life time of peak performance

You're in control of every life cycle phase of your drives. At the heart of drive services is a four-phase product life cycle management model. This model defines the services recommended and available throughout drives lifespan.

Now it's easy for you to see the exact service and maintenance available for your drives.

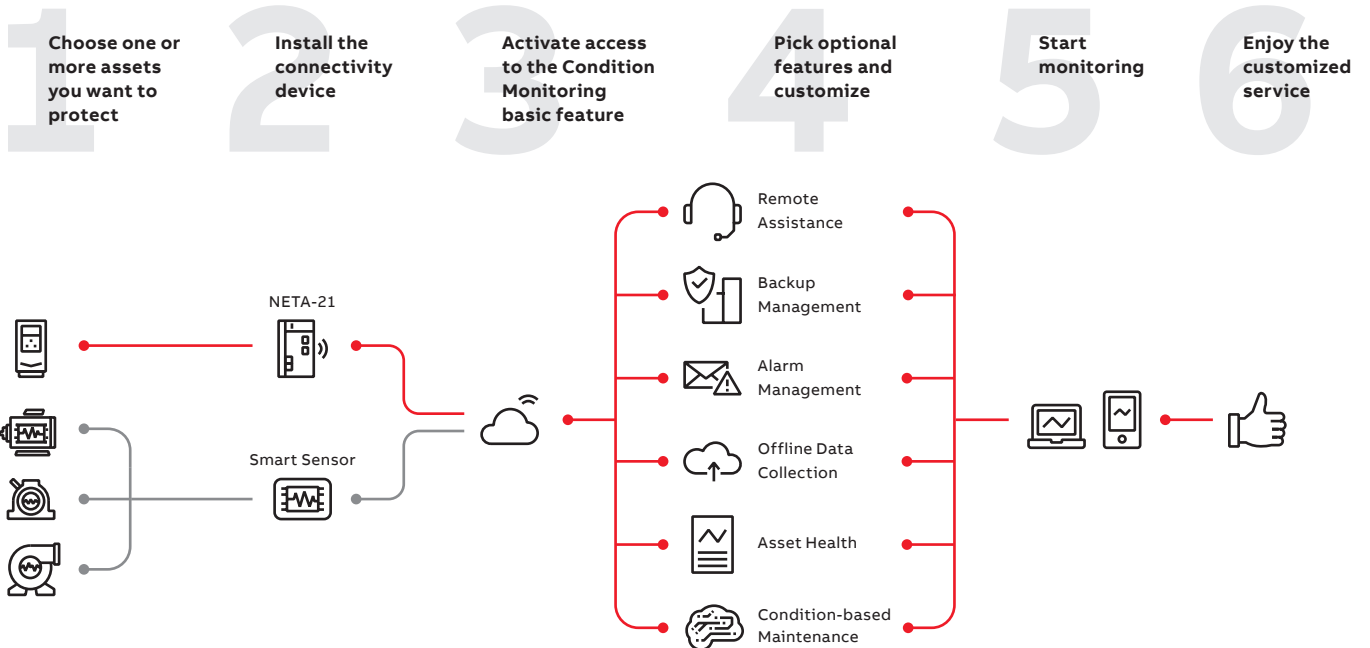
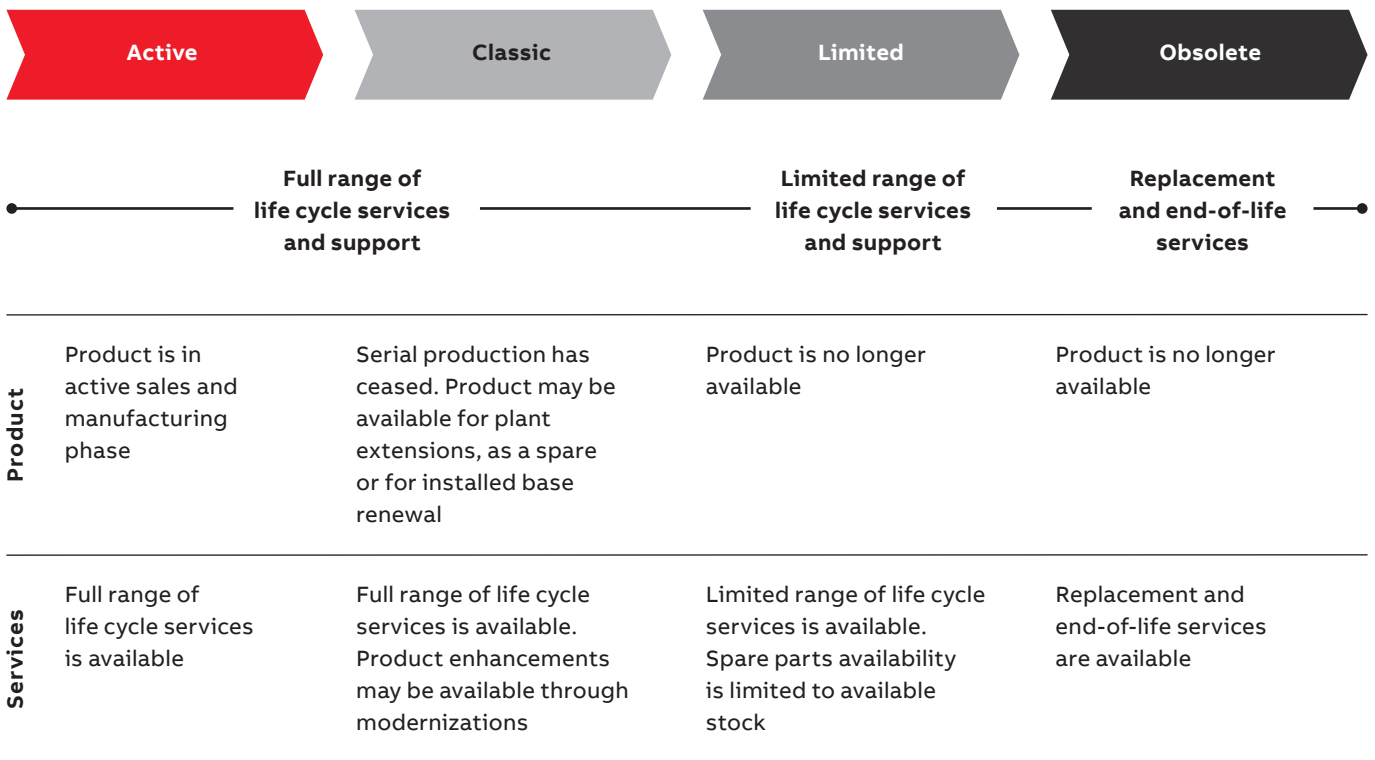

Keeping you informed throughout the life cycle

We notify you every step of the way using life cycle status statements and announcements.

Your benefit is clear information about your drives' status and precise services available. It helps you plan the preferred service actions ahead of time and make sure that continuous support is always available.

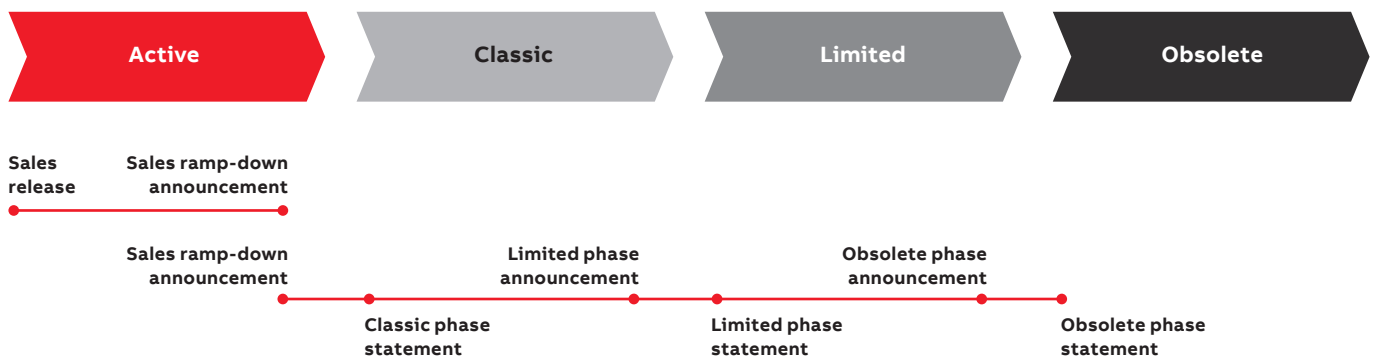

Sales release

Details about product portfolio and release schedule.

Sales ramp down announcement

Last time buy and last deliveries dates, informed well in advance.

Life cycle phase change announcement

Early information about the upcoming life cycle phase change and affects on the service availability. Informed well in advance, minimum six months prior to the change.

Life cycle phase statement

Information about the current life cycle status, product and services availability and recommended actions. Plan for the next life cycle phase transition.

Securing the flow of water and wastewater in the pump system

We want to be part of securing the operation of your water and wastewater utilities and distribution system. We want to help prevent any interruptions in your pump operation. We also want to ensure that the water is flowing in an effortless and energy efficient manner in accordance with required standards and regulations.



Complete offering of devices and services for the water industry

As a global partner, we can manage your water assets and bring you clear benefits from a total cost of ownership perspective. We do this by reducing costs throughout the whole life cycle of your pumping solution. Our portfolio includes drives, motors, PLCs and sensors. We also offer remote monitoring solutions to access information from a pump operating at a distance, saving time and reducing costs. Our devices have been designed to be compatible with each other, which ensures reliable communication and functionality.

Proactive maintenance for minimizing disruption to your pump and water distribution system

Motor-driven applications can be found throughout the water and wastewater industry. They have a high degree of reliance placed upon them and often perform critical duties and have a high in-service value. A possible failure of a device in the water and wastewater distribution system can result in loss of production, and introduce safety and environmental consequences. To reduce the risk of failure, each element of the pump solution – whether a drive, motor, bearing, coupling or gearing – must be properly maintained at the right times in their life cycle. From the moment you make the first enquiry to the disposal and recycling of each component, the services offered by ABB span the entire life cycle of your pump. Throughout the value chain, training, technical support and customized contracts are also available.



—
For more information, please contact
your local ABB representative or visit

new.abb.com/drives
new.abb.com/drives/drivespartners
new.abb.com/motors-generators

Online manuals for wall-mounted ACQ580-01 drives



Online manuals for ACQ580-04 drive modules



Online manuals for cabinet-built ACQ580-07 drives



Online manuals for wall-mounted ACQ580-31 ultra-low harmonic drives



Online manuals for ACQ580-34 ultra-low harmonic drive modules

